

PRELIMINARY



227 kW (Stage IIIa)

231 kW (Stage V)

200 kW (Electro)



83 - 110 t



17 - 21 m



MAXCAB

MASTERCAB

B55E Hybrid

Crawler material handler

Stage V



1962: rope-driven S833 with elevated operator cab

What makes up the E-Series

- 65 years of experience in designing and constructing hydraulic material handling machines
- Uncompromisingly high performance in all areas: Focus on material handling
- Technology that can be mastered: High-quality components without over-engineering
- Long service life and high value retention

Your top benefits

1

Green Efficiency

Save fuel - reduce operating costs
Work quietly - protect operator and environment



2

Top-level performance

Durable mechanical systems - stressed parts optimized
High speeds - high load capacities

3

Maximum usability

Maxcab comfort cab - work in comfort
SENCON - work program selection made easy



4

Maximum safety

Safe entry and exit - no-slip steps
State-of-the-art cameras - entire work area in view

5

Maintenance and service made easy

SENNEBOGEN control system - easy error diagnostics
Simple maintenance - clear labeling

6

Consultation and support in your area

3 production sites - 2 subsidiaries
150 sales partners - over 350 service stations





Subject to change. Additional options available upon request.

B55E Hybrid

The E-Series. At a glance.



Four ways to save fuel

- Up to 20 % savings: work in EcoMode with reduced engine speed
- Idle automation reduces speed to 40 % of operating speed
- Stop automation switches the engine off when not needed
- Optimized engine settings, reduced specific fuel consumption, state-of-the-art exhaust after treatment



Quiet operation 2

- Consistently quiet operation thanks to decoupled engine mounts and sound proofing in the doors
- Sound pressure level in accordance with 2000/14/EC as much as 2 dB lower than required

High-capacity cooling 3

- Constant, reliable performance thanks to large-dimensioned and robust fans and coolers
- Water and oil coolers with top-notch efficiency thanks to axial-piston pump and motor control and on-demand thermostatic control
- Fan reversal for cleaning in series



Maximum safety

- No-slip work surfaces
- Hand rails* **1**
- 2 cameras to the right and rear
- Step grid with railing next to cab sliding door
- Protective grating, windshield/roof

Powerful hydraulic system **4**

- Strong pumps with power reserves
- Top efficiency thanks to large hydraulic valves and lines
- Extra-long change intervals of 4,000 operating hours through initial fill-up with special oil with extended service life when using SENNEBOGEN HydroClean*

* Option



The premium cab.

Panoramic view

Features

- optimum cab climate with automatic air conditioning system, partial tinted glass
- pleasant and equal temperature dispersion by means of 9 nozzles
- panoramic view
- comfort seat with air suspension
- very quiet through optimized noise insulation
- highest safety & comfort with sliding door, wide door opening
- ergonomically arranged operating controls for fatigue-free and relaxed working
- 12 V, 24 V, and USB charging sockets, hands-free telephone preparation, document box
- various options: electric cool box behind driver's seat, seat air conditioning

Our SENNEBOGEN joysticks

- consoles and ergonomic joysticks that move with the seat
- pleasant grip through ergonomic design
- precise control of all movements through direct and sensitive function activation
- quick access to all operating controls through optimized design of all push-buttons and switches



Optimized for maintenance

- Fast and easy diagnosis thanks to the clearly labeled electrical distributor
- Easy accessibility to all service points of the machine
- Automatic central lubrication for equipment and slewing gear raceway



SENNEBOGEN Hydro Clean*

- Optimal protection of hydraulic components thanks to 3 µm micro-filter
- Cleaner hydraulic oil, longer service life



Central measuring points

- Easily accessible
- Quickly inspect entire hydraulic system

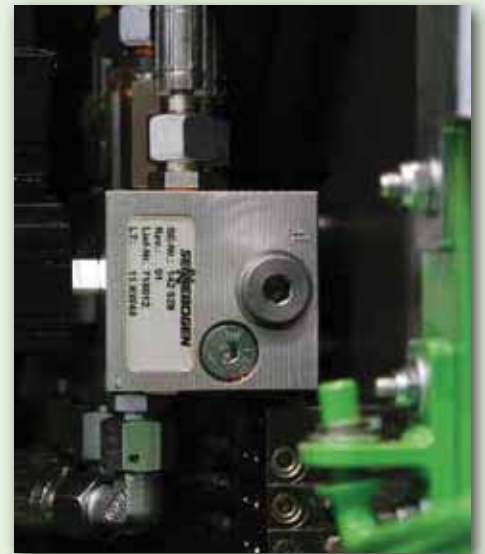

Clear labeling

- All parts labeled with a unique part number
- Easy and reliable spare parts ordering



Modular design - versatile solutions

Attachments

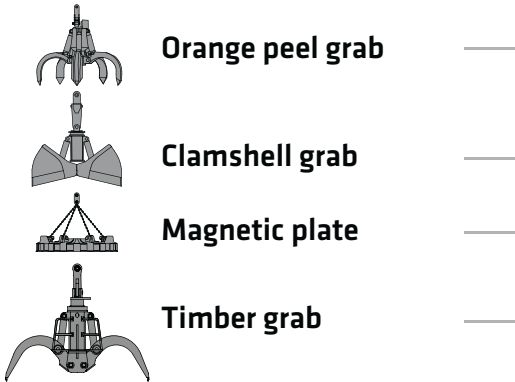

Equipment options (others available upon request)

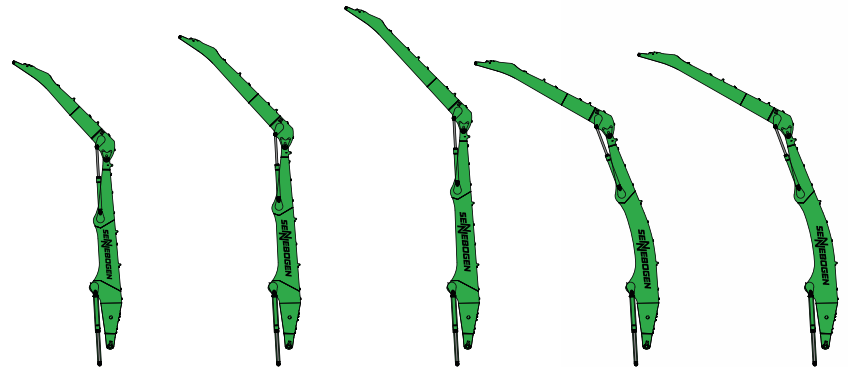

Cabs



Cab elevation

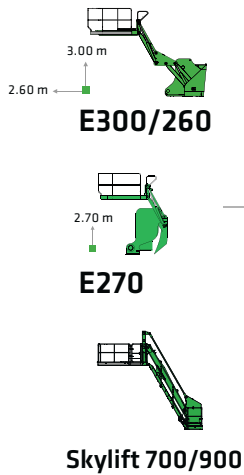

K17 K19 K21 B19 B20

Uppercarriage

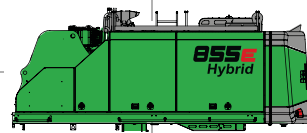

Diesel-hydraulic drive



Electrohydraulic drive

Options



Motorized cable reel



Transformer

Undercarriage variants

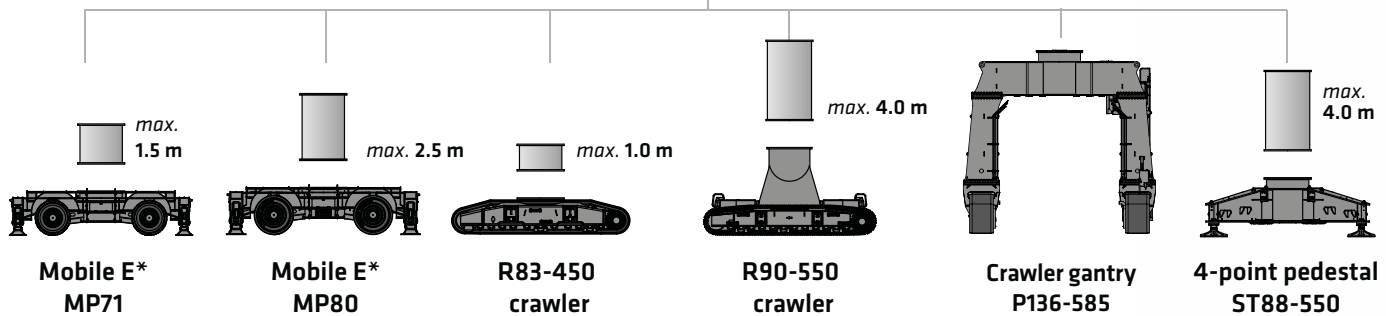

BSS
Hybrid

Advantages at a glance

- decade-long experience
- most advanced computer simulation
- the greatest degree of stability and longest service life



Reliable working thanks to robust and FEM optimized equipment

Better illumination of the work area through powerful LED headlights*

High load capacities even when fully extended, thanks to massive cylinders

Ideal overview and safe working height thanks to stable cab elevation

Safe entry and exit thanks to railings, grip handles and no-slip steps

SENEBOGEN
GreenHybrid

Safe entry and exit thanks to platform with railing

High stability

Robust side covers made from recyclable sheet steel

MACHINE TYPE

Model (type) **855**

ENGINE

Power **Stage V:**
Rated power: 231 kW at 2100 min⁻¹
237 kW at 2000 min⁻¹ / 242 kW at 1800 min⁻¹

Stage IIIa:
Rated power: 227 kW at 2000 min⁻¹
254 kW at 1800 min⁻¹

Model **Cummins L9**
Direct injection, turbo charged, intercooling, reduced-emission, ECO mode, idle automation, fuel preheating

Cooling Water-cooled

Air filter Dry filter with pre-separator, automatic dust discharge, main element and safety element, contamination indicator

Fuel tank **1000 l**

DEF tank **100 l**

Electr. system **24 V**

Batteries **2 x 150 Ah**, battery disconnect switch

Options

- Engine block heater
- Electric fuel pump

UPPERCARRIAGE

Design Torsion-resistant box design, precision crafted, steel bushings for boom bearings. Clear, service-friendly concept, engine installed in the longitudinal engine

Central lubrication Automatic central lubrication for uppercarriage, slewing gear

Electrical system Central electrical distributor, battery disconnect switch

Cooling system 3-circuit cooling system with high cooling output, thermostatically regulated fan drive for oil cooler and water cooler, fan reversal for cleaning

Options

- Slewing gear brake via foot pedal
- LED lighting packages
- Fire extinguisher
- Sea climate resistant coating
- Electric hydraulic tank preheating for temperatures below -20 °C
- Low-temperature package for use at temperatures below -20 °C
- Hydraulically-driven magnetic generator 20 kW / 25 kW
- SENtrack DS telematic system

HYDRAULIC SYSTEM

Load-sensing/LUDV hydraulic system for work and travel systems

Pump type Swash plate-type variable-displacement piston pump, load pressure-independent flow distribution for simultaneous, independent control of work functions

Pump control Zero-stroke control, on-demand flow control - the pumps only pump as much oil as will actually be used, pressure purging, load limiting, sensing control

Operating pressure **350 bar**

Filtration High-performance filtration with long change interval
SENNEBOGEN HydroClean micro-filter water separation system, optional

Hydraulic tank **900 l**

Flow rate max. **2 x 369 l/min** and **1 x 240 l/min** for rotary drive in the closed circuit

Control system Proportional, precision hydraulic actuation of work movements, 2 hydraulic servo joysticks for the work functions, additional functions via switches and foot pedals

Safety Hydraulic circuits with safety valves, secured emergency lowering of the equipment at engine standstill, pipe fracture safety valves for lift cylinder and stick cylinder

Options

- Bio-oil - environmentally friendly
- Tool Control for programming pressure/rate of up to 10 tools
- Supplemental hydraulic circuit for shear attachment
- Load torque warning with capacity display
- Overload safeguard with shutdown
- 60 µm pressure filter for attachments
- 3 µm hydraulic micro-filter - SENNEBOGEN HydroClean

SLEWING DRIVE

Gearbox Compact planetary gear with bent-axis hydraulic motor, integrated brake valves

Parking brake Spring-loaded multi-disk brake

Slewing ring Very strong slewing ring sealed with pinion lubrication

Slewing speed 0-5,5 rpm, variable

CAB 	
Cab elevation	E270, hydraulically elevating cab
Cab equipment	Sliding door inc. sliding pane, vibration damped, tinted safety glass, front pane can be opened, roof window, windscreen wiper for front pane, radio preparation, air-suspended comfort seat, joystick steering, SENNEBOGEN SENCON control & diagnosis system
Options	<ul style="list-style-type: none"> ■ 30 ° tiltable cab ■ Cab elevation E300/260, can be elevated and moved forward hydraulically ■ Cab elevation Skylift 700/900 ■ Mastercab (Large-capacity port cab) ■ Maxcab Industry ■ Armored-glass windshield ■ Armored-glass sunroof ■ Safety side window and rear window ■ Windscreen wiper for front window/skylight ■ Rolling shade for roof window and windshield ■ FOPS protective roof guard ■ Protective front guard ■ Charcoal filter for circulating and outside air ■ Auxiliary heating ■ Climatic seat ■ Radio ■ Electric cool box

EQUIPMENT 	
Design	Decades of experience and the latest computer simulations guarantee the greatest degree of stability and life-span. Oversized bearing points with low-maintenance, sealed special bushings, precision-crafted.
Cylinders	Hydraulic cylinders with high-quality sealing and guide elements, end position damping, sealed bearing points
Options	<ul style="list-style-type: none"> ■ Ball valves in the hydraulic lines for quick and easy grab switching ■ Sea climate resistant coating ■ Sea climate resistant coating of all cylinders, nickel-plated and chrome-plated ■ Float position of the equipment ■ Hoisting limiter / stick limitation adjustable for stop settings, e.g. in the hall ■ Boom damping

UNDERCARRIAGE 	
Design	Wide-gauge crawler undercarriage in stable, torsionally rigid box construction
Drive	Hydraulic travel drive, integrated in the traveling gear frame for each traveling gear side through an axial piston motor via compact planetary gear.
Parking brake	Spring-loaded, hydraulically ventilated disk brakes. Hydraulic brake valves protect the drive engines when moving downhill.
Traveling gear	R83-450 telescopic crawler undercarriage with 2.8 - 4.5 m mechanical track adjustment and maintenance-free B7 crawler track with canted 800 mm triple grouser track shoes
Speed	0 - 1.6 km/h Stage I, 0 - 3 km/h Stage II
Options	<ul style="list-style-type: none"> ■ R90-550 crawler undercarriage ■ Maintenance-free B7 crawler track with 900 mm flat track shoes

ELECTRIC DRIVE 	
Option	<ul style="list-style-type: none"> ■ Power: 200 kW / 400 V / 50 Hz Total connected load 340 kVA, machine side fuse 400 A (alternatively 425 A with magnet system) for 400 V - star-delta connection motor start ■ Advantages: lowest operating costs, low-noise and virtually vibration-free work, long service life of the hydraulic components

OPERATING WEIGHT 	
Mass	approx. 83,000 kg basic 855 R machine with R83/450 undercarriage, K17 with grab
Note	Operating weight varies by model and equipment.

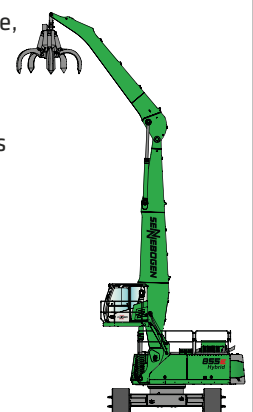

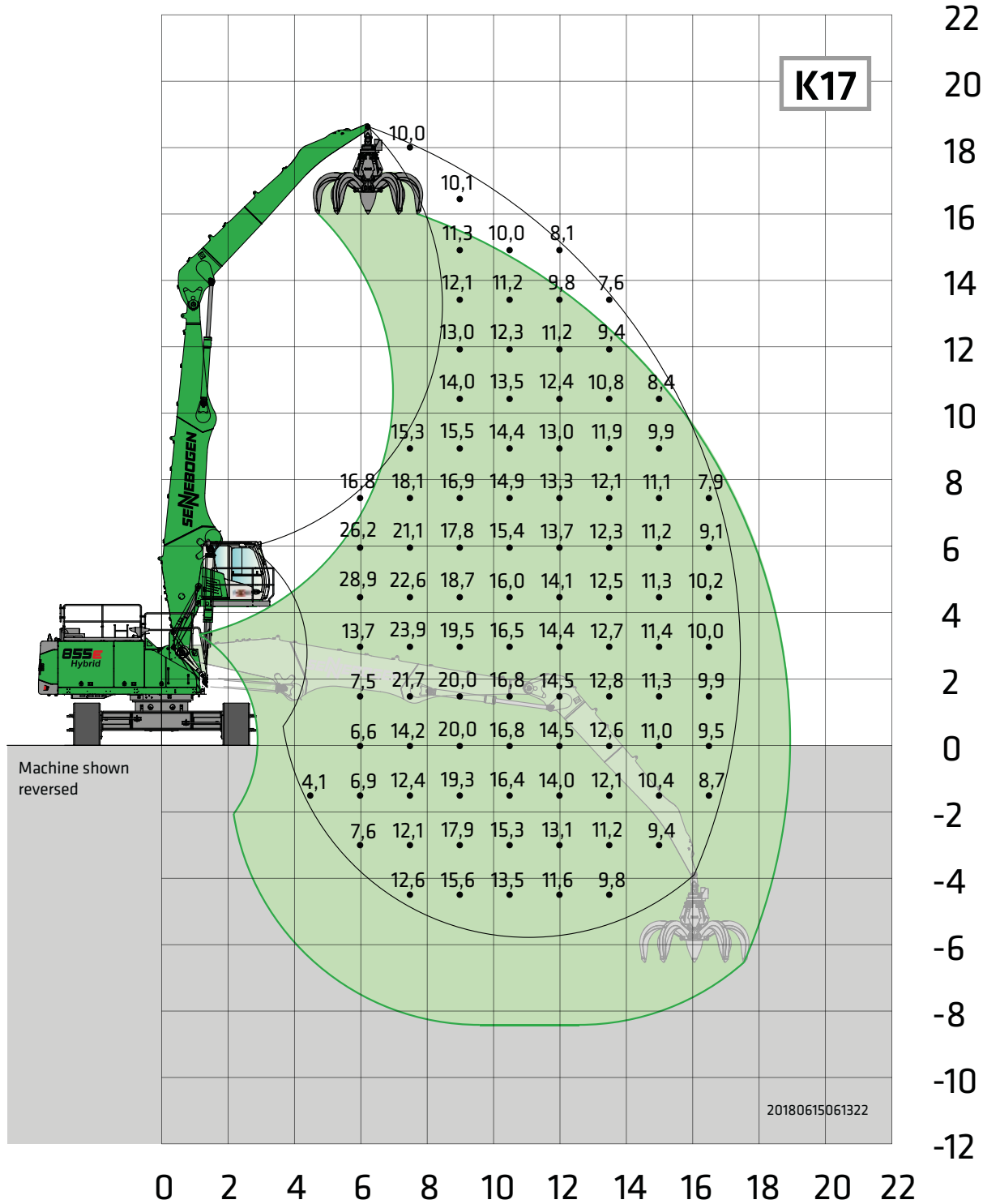

Undercarriage	R83-450	Compact boom	10.5 m	Cab	Maxcab E270
		Grab stick	7.5 m		hydraulically elevating

All load ratings are specified in tons (t) and apply at the end of the stick, without attachment, on solid, level ground. Attachments such as grabs, magnets, load hooks, etc. are part of the specified load ratings. The specified values are 75% of the static tipping load or 87% of the hydraulic lifting force in accordance with ISO 10567, and apply at the required operating temperature in the Green Hybrid system. In accordance with EU standard EN 474 / 5, hydraulic material handling machines used for hoisting must be equipped with pipe fracture safety devices on the hoist and stick cylinders and an overload warning device. Load ratings apply to max. gauge and they are 360° slewing.



Load ratings

R

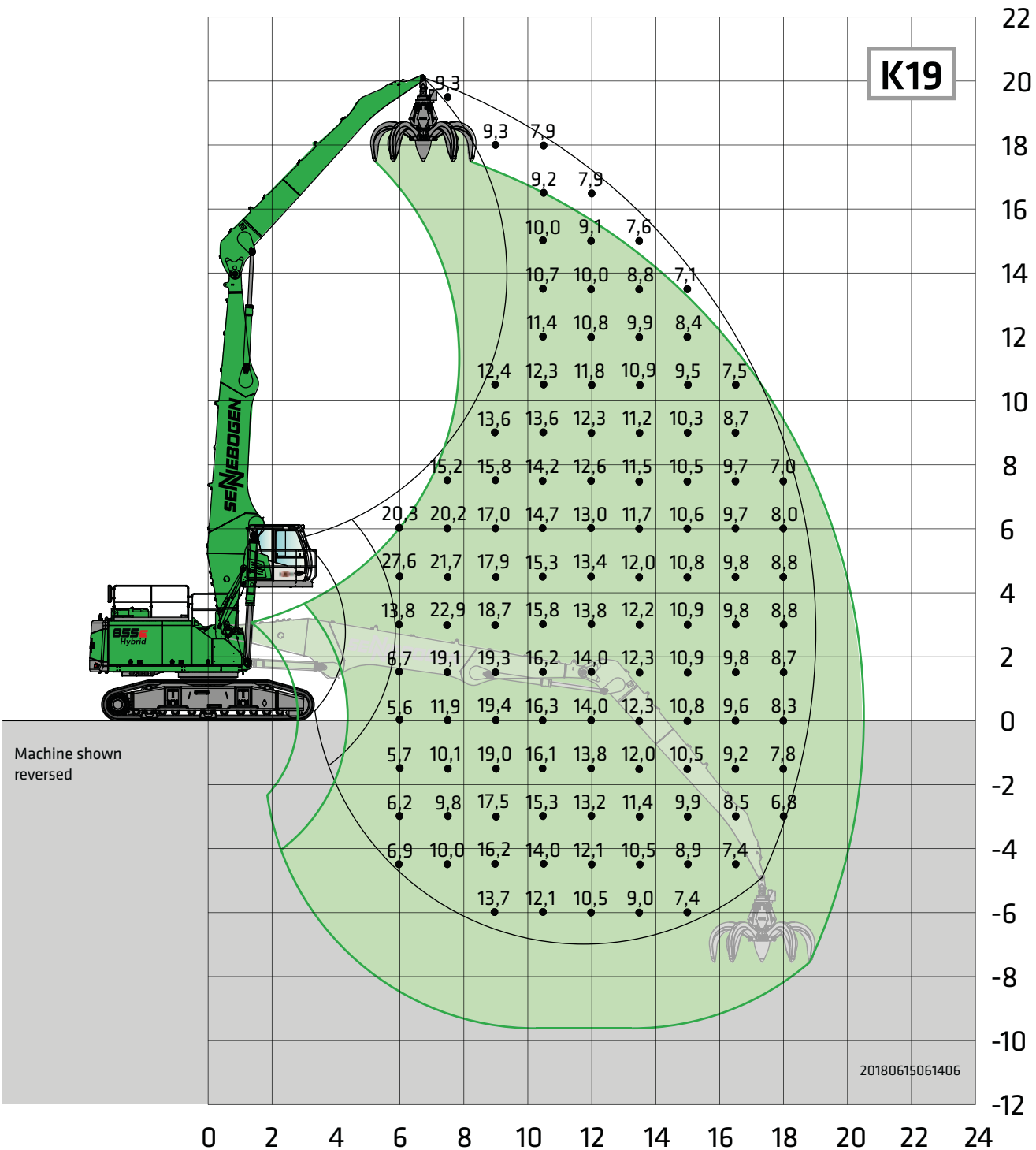

Undercarriage	R83-450	Compact boom	11.2 m	Cab	Maxcab E270,
		Grab stick	8.5 m		hydraulically elevating

All load ratings are specified in tons (t) and apply at the end of the stick, without attachment, on solid, level ground. Attachments such as grabs, magnets, load hooks, etc. are part of the specified load ratings. The specified values are 75% of the static tipping load or 87% of the hydraulic lifting force in accordance with ISO 10567, and apply at the required operating temperature in the Green Hybrid system. In accordance with EU standard EN 474 / 5, hydraulic material handling machines used for hoisting must be equipped with pipe fracture safety devices on the hoist and stick cylinders and an overload warning device. Load ratings apply to max. gauge and they are 360° slewing.

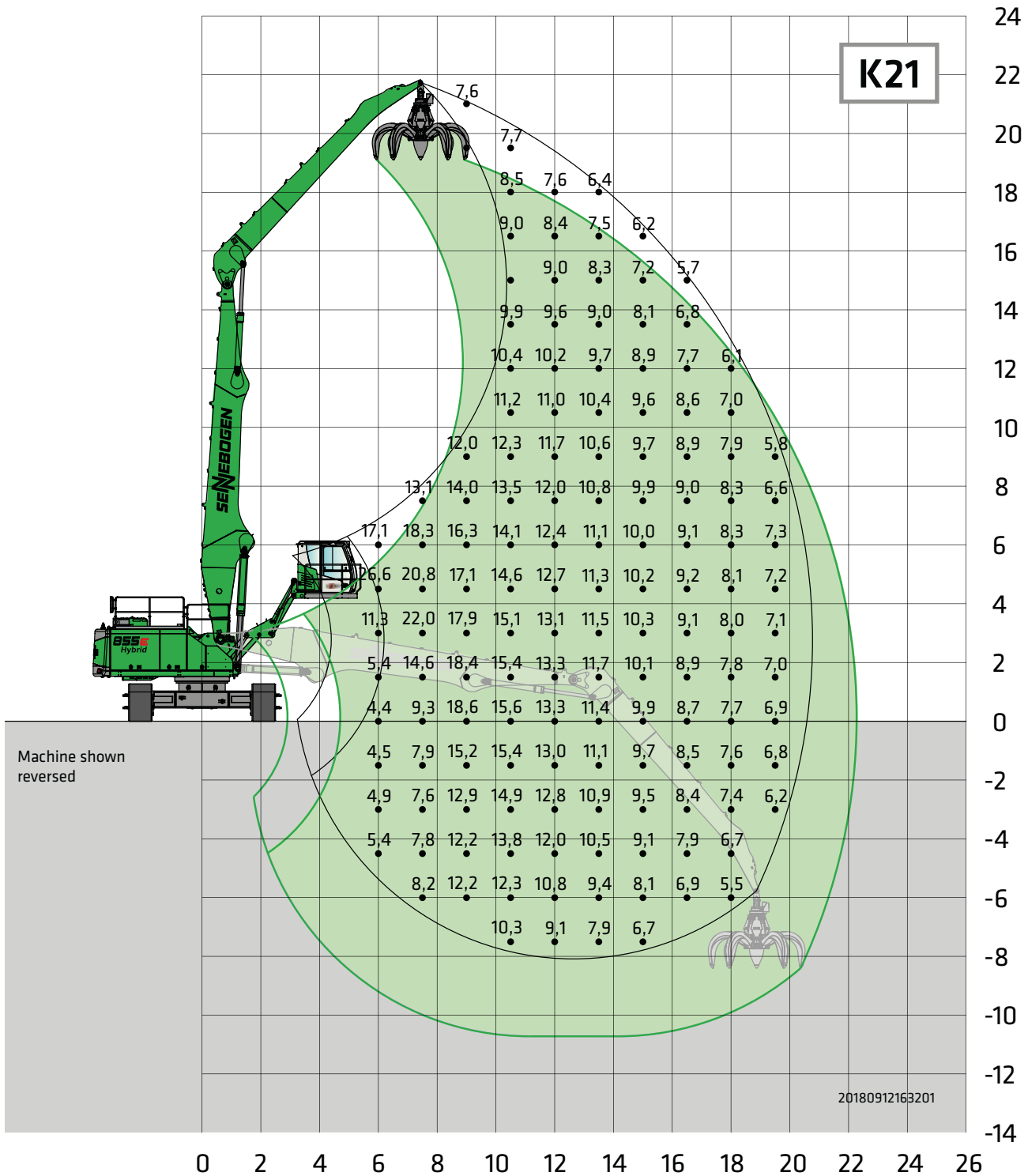

Undercarriage	R83-450	Compact boom Grab stick	12.1 m 9.5 m	Cab	Maxcab E300/260, can be elevated and moved forward hydraulically
---------------	---------	----------------------------	-----------------	-----	--

All load ratings are specified in tons (t) and apply at the end of the stick, without attachment, on solid, level ground. Attachments such as grabs, magnets, load hooks, etc. are part of the specified load ratings. The specified values are 75% of the static tipping load or 87% of the hydraulic lifting force in accordance with ISO 10567, and apply at the required operating temperature in the Green Hybrid system. In accordance with EU standard EN 474 / 5, hydraulic material handling machines used for hoisting must be equipped with pipe fracture safety devices on the hoist and stick cylinders and an overload warning device. Load ratings apply to max. gauge and they are 360° slewing.



Load ratings

R

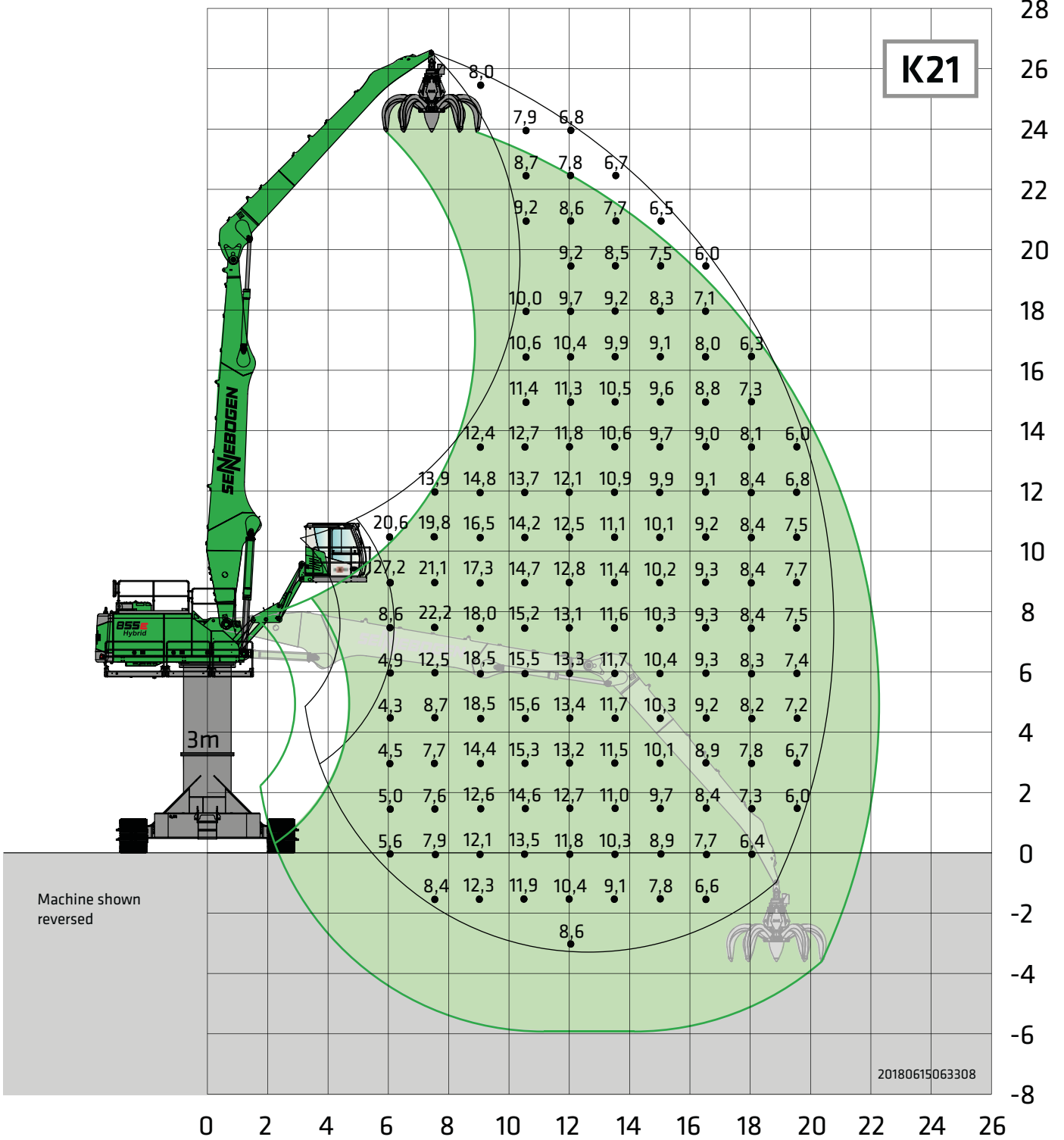

Undercarriage Pylon	R90/550 3 m	Compact boom Grab stick	12.1 m 9.5 m	Cab	Maxcab E300/260, can be elevated and moved forward hydraulically
-------------------------------	-----------------------	-----------------------------------	------------------------	------------	---

All load ratings are specified in tons (t) and apply at the end of the stick, without attachment, on solid, level ground. Attachments such as grabs, magnets, load hooks, etc. are part of the specified load ratings. The specified values are 75% of the static tipping load or 87% of the hydraulic lifting force in accordance with ISO 10567, and apply at the required operating temperature in the Green Hybrid system. In accordance with EU standard EN 474 / 5, hydraulic material handling machines used for hoisting must be equipped with pipe fracture safety devices on the hoist and stick cylinders and an overload warning device. Load ratings apply to max. gauge and they are 360° slewing.

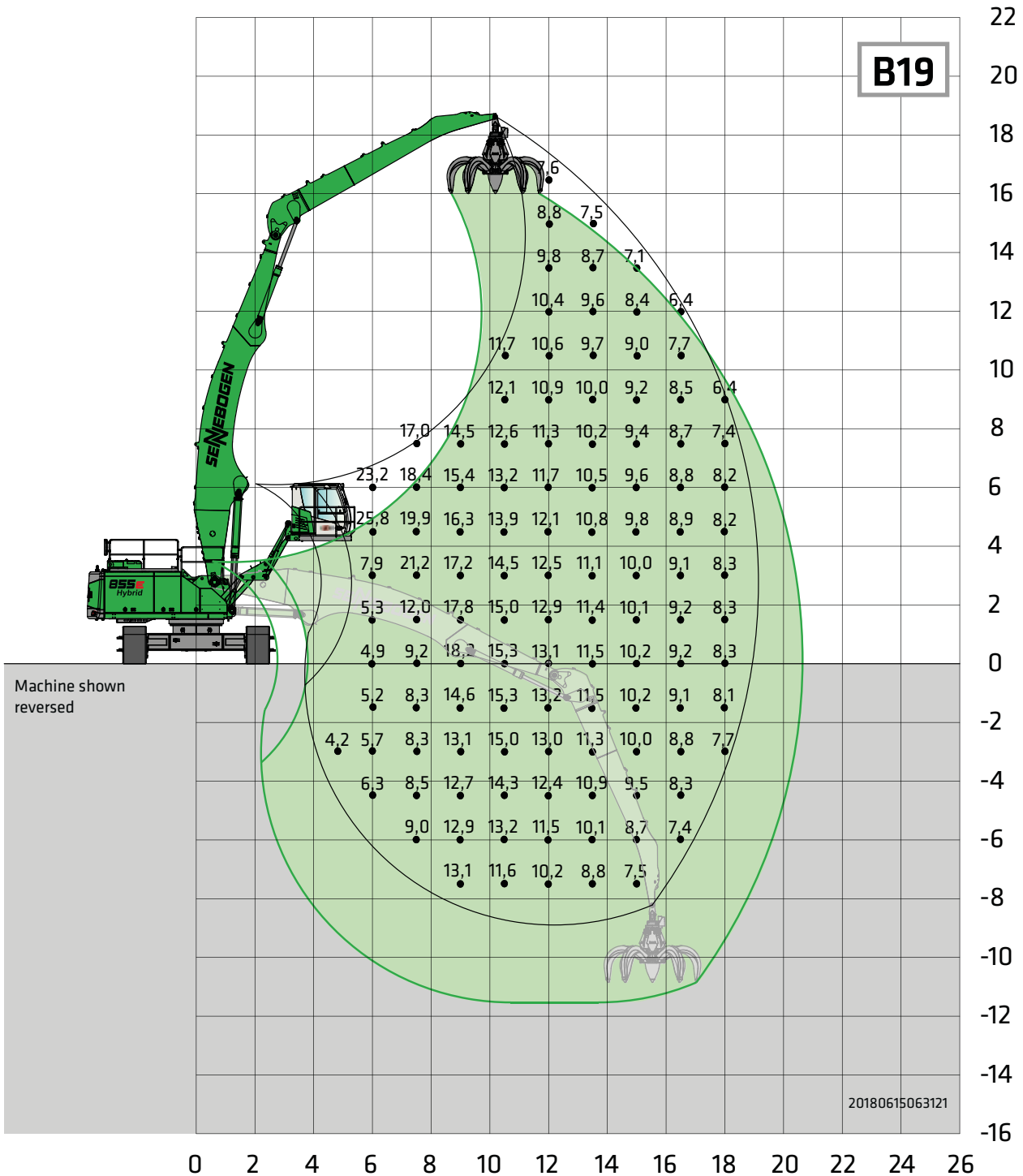

Undercarriage	R83-450	Compact boom	12 m Banana	Cab	Maxcab E300/260, can be elevated and moved forward hydraulically
		Grab stick	8.5 m		

All load ratings are specified in tons (t) and apply at the end of the stick, without attachment, on solid, level ground. Attachments such as grabs, magnets, load hooks, etc. are part of the specified load ratings. The specified values are 75% of the static tipping load or 87% of the hydraulic lifting force in accordance with ISO 10567, and apply at the required operating temperature in the Green Hybrid system. In accordance with EU standard EN 474 / 5, hydraulic material handling machines used for hoisting must be equipped with pipe fracture safety devices on the hoist and stick cylinders and an overload warning device. Load ratings apply to max. gauge and they are 360° slewing.



Load ratings

R

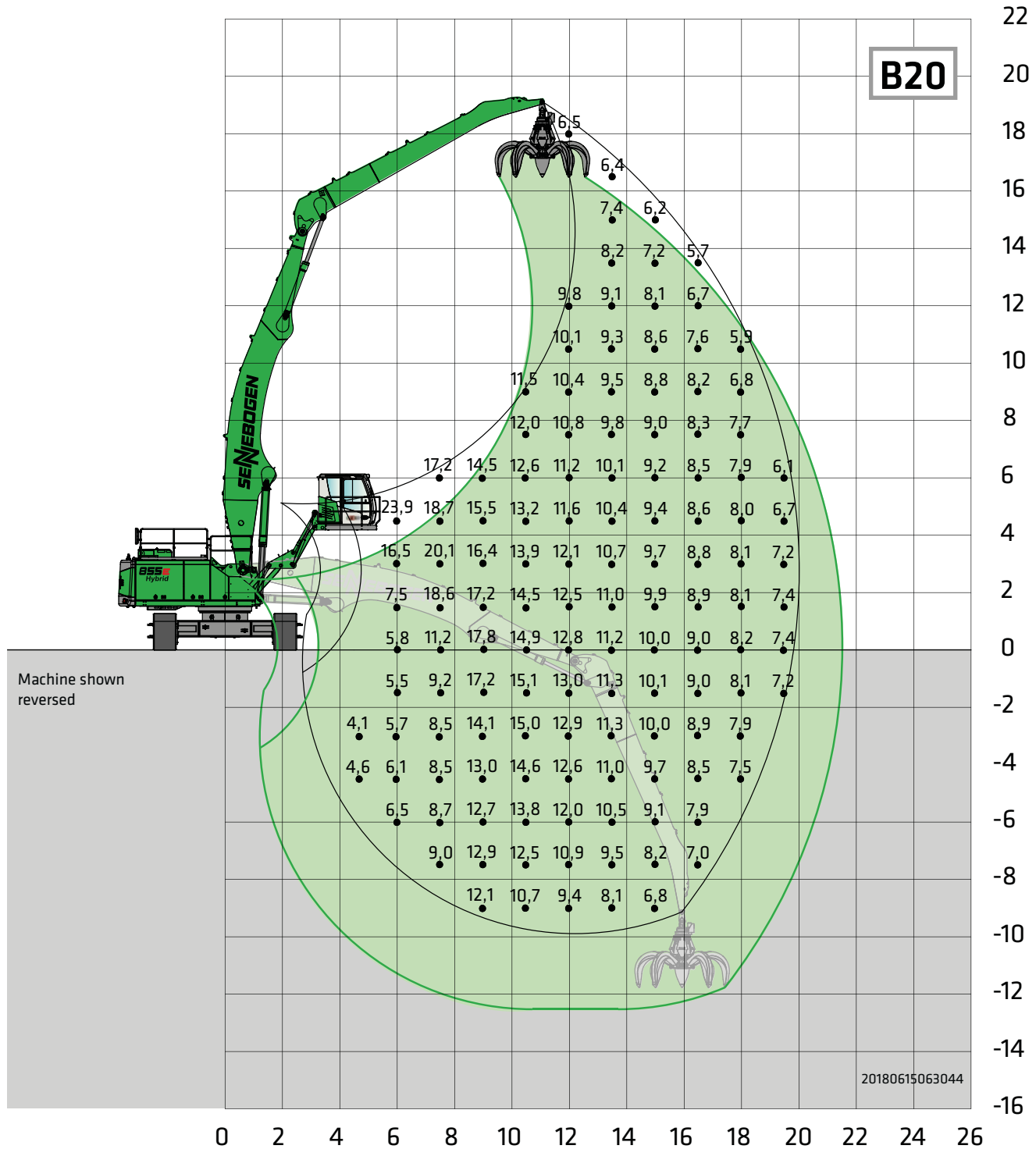

Undercarriage	R83-450	Compact boom	12 m Banana	Cab	Maxcab E300/260, can be elevated and moved forward hydraulically
		Grab stick	9.5 m		

All load ratings are specified in tons (t) and apply at the end of the stick, without attachment, on solid, level ground. Attachments such as grabs, magnets, load hooks, etc. are part of the specified load ratings. The specified values are 75% of the static tipping load or 87% of the hydraulic lifting force in accordance with ISO 10567, and apply at the required operating temperature in the Green Hybrid system. In accordance with EU standard EN 474 / 5, hydraulic material handling machines used for hoisting must be equipped with pipe fracture safety devices on the hoist and stick cylinders and an overload warning device. Load ratings apply to max. gauge and they are 360° slewing.

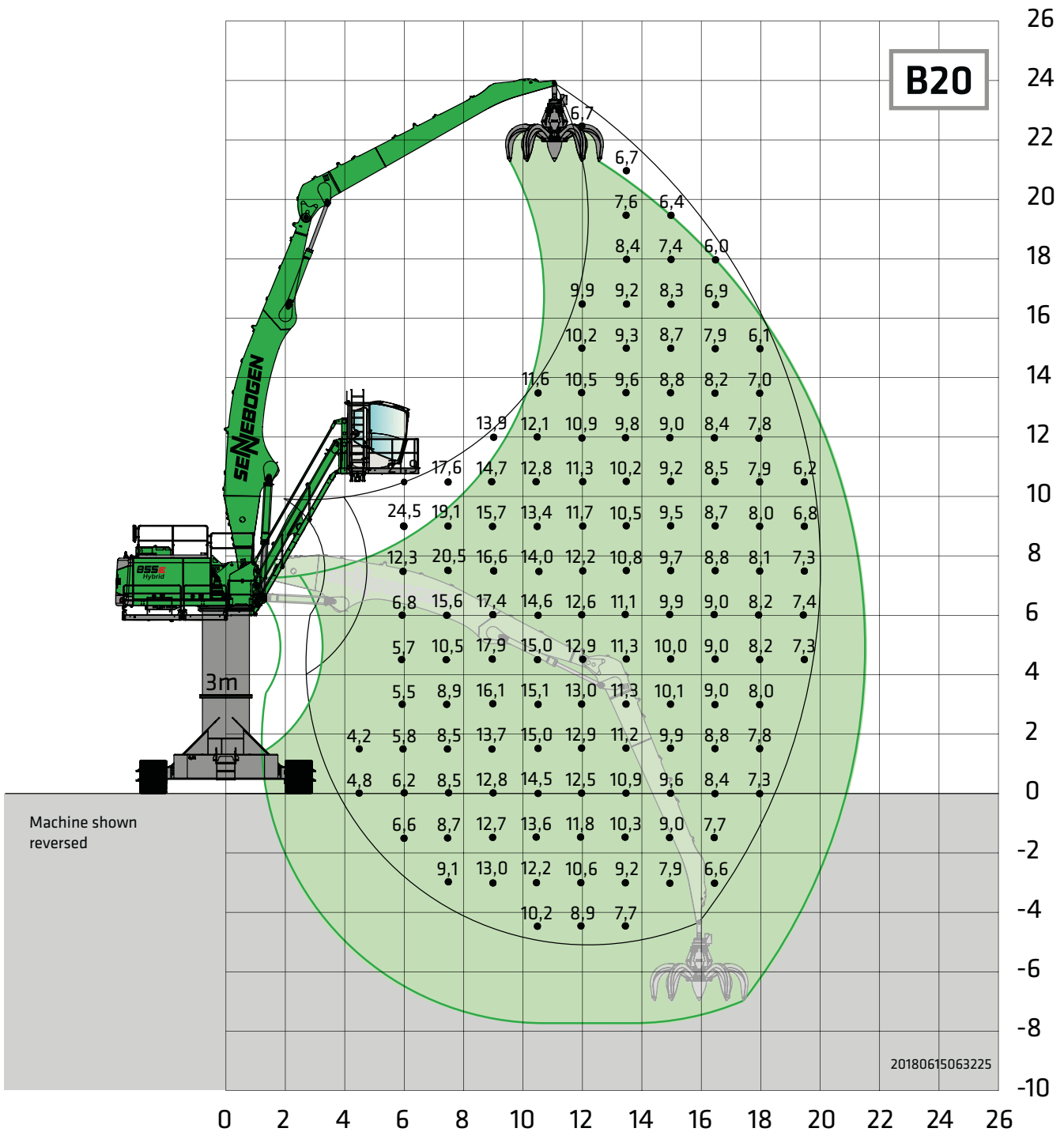

Undercarriage R90-550 Pylon	R90-550 3 m	Compact boom Grab stick	12 m Banana 9.5 m	Cab	Skylift 900 Mastercab hydraulic elevation
--	-----------------------	-----------------------------------	-----------------------------	------------	---

All load ratings are specified in tons (t) and apply at the end of the stick, without attachment, on solid, level ground. Attachments such as grabs, magnets, load hooks, etc. are part of the specified load ratings. The specified values are 75% of the static tipping load or 87% of the hydraulic lifting force in accordance with ISO 10567, and apply at the required operating temperature in the Green Hybrid system. In accordance with EU standard EN 474 / 5, hydraulic material handling machines used for hoisting must be equipped with pipe fracture safety devices on the hoist and stick cylinders and an overload warning device. Load ratings apply to max. gauge and they are 360° slewing.

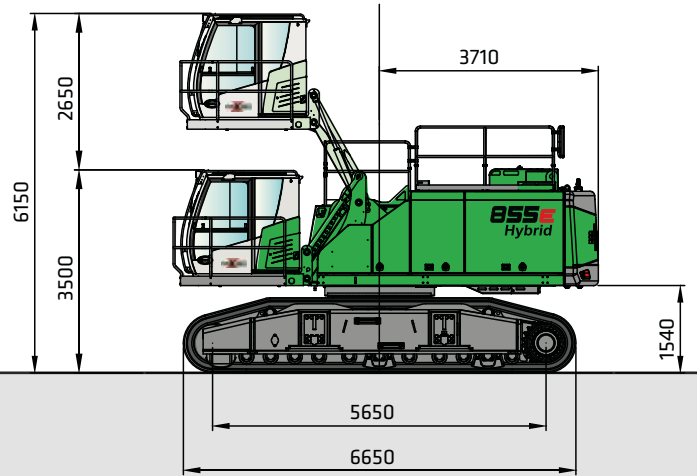
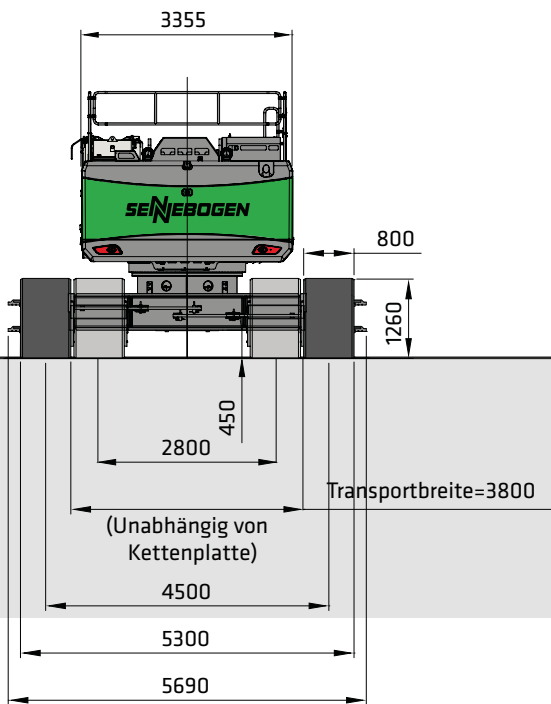

855 R with R83-450 undercarriage and Maxcab E270 cab, can be elevated hydraulically

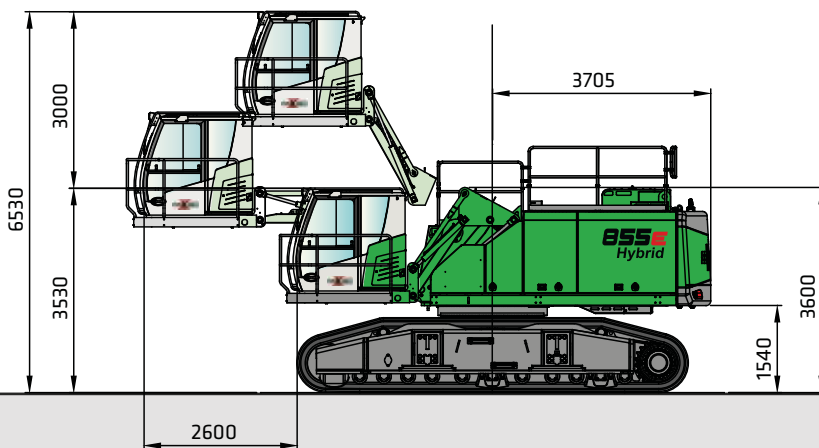

855 R with R83-450 undercarriage and Maxcab E300/260 cab, can be elevated and moved forward hydraulically

B55E Hybrid Dimensions

R

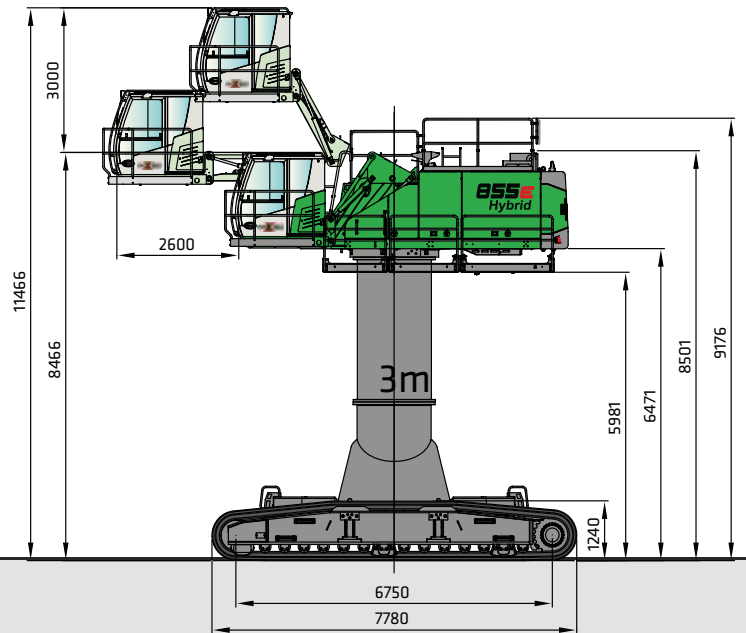
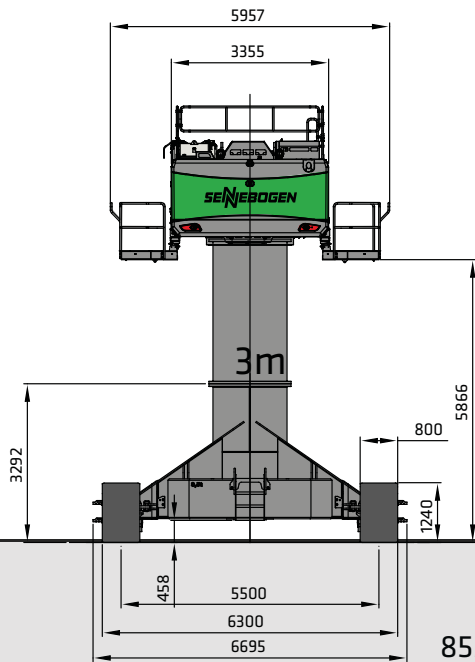

855 R with undercarriage R90-550 and 3.0 m pylon, Maxcab E300/260 can be elevated and moved forward hydraulically

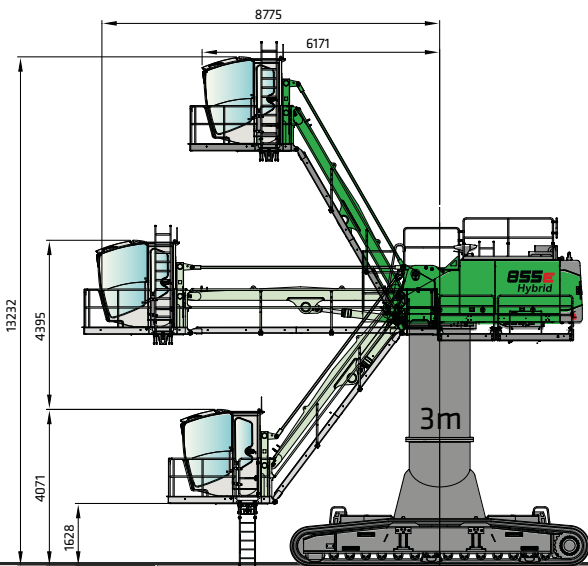

855 R with undercarriage R90-550 and 3.0 m pylon, Mastercab with Skylift 900 and hydraulic elevation feature

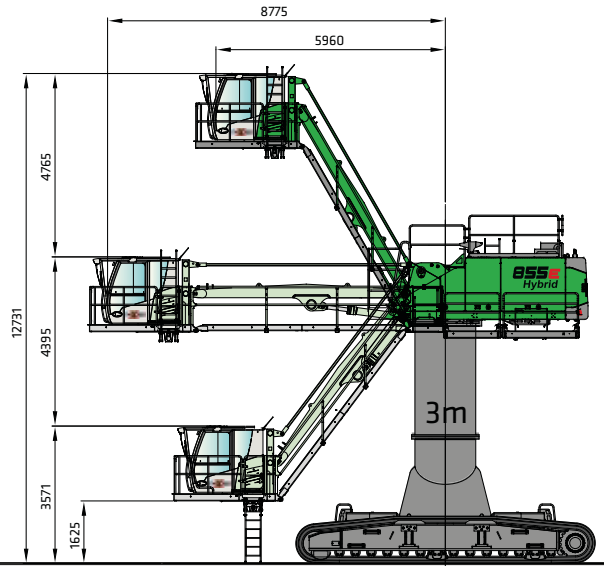

855 R with undercarriage R90-550 and 3.0 m pylon, Maxcab Industry with Skylift 900 and hydraulic elevation feature

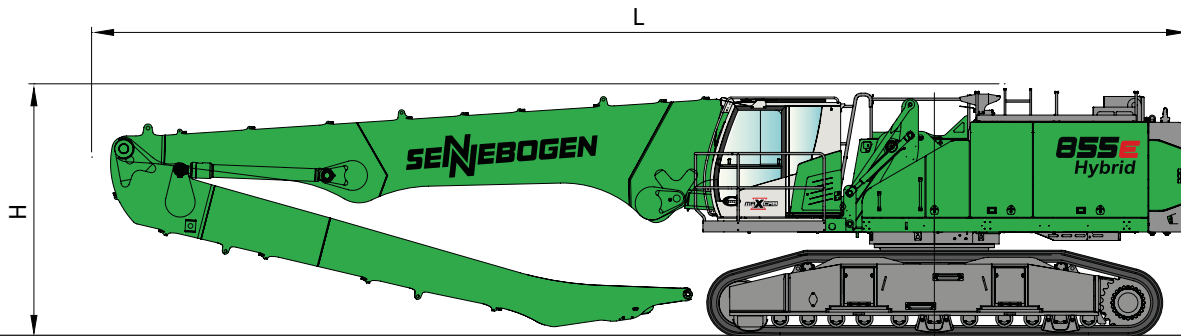

	Load boom	Grab stick	Transport length (L)	Transport height (H)
K17	10.5 m	7.5 m	15.3 m	3.65 m
K19	11.2 m	8.5 m	16.0 m	3.70 m
K21	12.1 m	9.5 m	16.9 m	3.85 m
B19	12.0 m banana	8.5 m	16.7 m	3.85 m
B20	12.0 m banana	9.5 m	16.7 m	3.85 m

Note:

This catalog describes machine models, scope of equipment of individual models, and configuration options (standard equipment and optional equipment) of the machines delivered by SENNEBOGEN Maschinenfabrik.

Machine illustrations can contain optional equipment and supplemental equipment. Actual equipment may vary depending on the country to which the machines are delivered, especially in regard to standard and optional equipment and tolerances.

B55E
Hybrid

SENNEBOGEN Green Hybrid Energy Recovery System



Save 30 % energy with the Green Hybrid system

- A combination of hydraulic cylinders at the outrigger and nitrogen piston accumulators with gas recover energy during the work procedure
- Use of the recovered energy during the next working cycle reduces the engine power required



Safety

- Use of standard hydraulic components
- Energy storage in the enclosed rear section

Reduced operating costs

- High quality components for long service life and reliability
- Proven concept: been used successfully since 2013
- High system efficiency - already very effective in small lifting movements



Recommended grabs

SGM orange peel grab (4 shells)



Design/size	Grab capacity	Weight ¹		max. piled density
		Shell		
		HO	G	
SGM	l	kg	kg	t / m ³
800.50-4	800	2245	2490	2.0
1000.50-4	1000	2345	2585	
1500.50-4	1500	2475	2830	
2000.50-4	2000	2660	3075	

SGM orange peel grab (5 shells)



Design/size	Grab capacity	Weight ¹		max. piled density
		Shell shape ²		
		HO	G	
SGM	l	kg	kg	t / m ³
800.50	800	2580	2740	2.0
1000.50	1000	2710	2870	
1500.50	1500	2860	3100	
2000.50	2000	3060	3615	
2500.50	2500	3130	3615	
3000.50	3000	3250	3875	
3500.50	3500	3420	4140	

SGZ clamshell grab



Design/size	Grab capacity	Weight ¹	max. piled density
	l	kg	t / m ³
SGZ			
1500.50	1500	1950	2.6
2000.50	2000	2200	
2500.50	2500	2300	2.0
3000.50	3000	2490	
4000.50	4000	2800	1.6

Magnetic plates



Type series/model	Power	Dead weight	Pull-off strength	Load-bearing capacity in kg
WOKO	kW	kg	kN	Slab (safety factor 2)
S-RLB 15	11.7	2400	380	19000
S-RLB 17	17.8	3300	640	32000
S-RLB 19	22.0	5090	790	39500
Recommended magnetic generator: 20 - 25 kW				

*) Available upon request

¹) Weight information without grab suspension, stick bolts, hose system

²) Half-open shells: shell sheet steel width 400 mm, 500 mm for 1,250 l capacity and higher

B55E

R

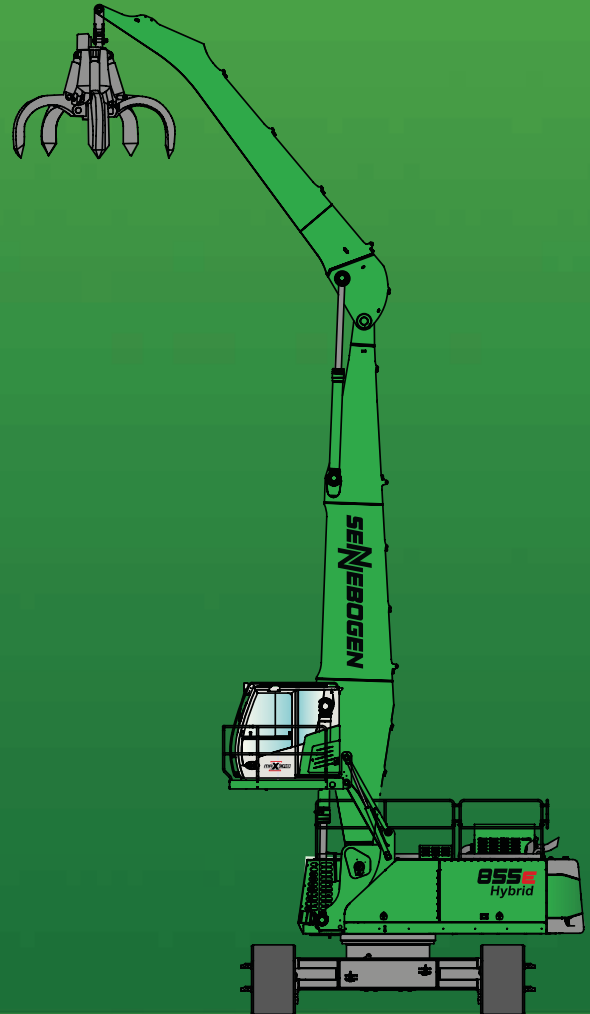

This catalog describes machine models, scopes of equipment of individual models, and configuration options (standard equipment and optional equipment) of the machines delivered by SENNEBOGEN Maschinenfabrik GmbH. Machine illustrations can contain optional equipment and supplemental equipment. Actual equipment may vary depending on the country to which the machines are delivered, especially in regard to standard and optional equipment and tolerances.

All product designations used may be trademarks of SENNEBOGEN Maschinenfabrik GmbH or other supplying companies, and any use by third parties for their own purposes may violate the rights of the owners.

Please contact your local SENNEBOGEN sales partner for information concerning the equipment variants offered. Requested performance characteristics are only binding if they are expressly stipulated upon conclusion of the contract. Delivery options and technical features are subject to change. Errors and omissions excepted. Equipment is subject to change, and rights of advancement are reserved.

© SENNEBOGEN Maschinenfabrik GmbH, Straubing, Germany. Reproduction in whole or in part only with written consent of SENNEBOGEN Maschinenfabrik GmbH, Straubing, Germany.

SENNEBOGEN

SENNEBOGEN
Maschinenfabrik GmbH
Sennebogenstraße 10
94315 Straubing, Germany

Tel. +49 9421 540-144/146
marketing@sennebogen.de

Order no. 299212
855 R-E-041610-111810-021910-1119.du

GO FOR GREEN

 www.sennebogen.com