

HOOKLOADER & SKIPLOADER

MOUNTING ACCESSORIES 2023

LIFETIME EXCELLENCE



CONTENT INHALT INDEX

General accessories / Allgemeines Zubehör / Accessoires généraux

Pump and tank <i>Pumpe und Tank</i> Pompe et réservoir	04 - 09
Underride protection <i>Unterfahrerschutz</i> Barre anti-encastrément	10 - 11
Side protection <i>Seitliche Schutzvorrichtung</i> Pare-cyclistes	12 - 13
Mudguards <i>Kotflügel</i> Ailes	14 - 17
Mounting brackets for accessories <i>Montagehalter für Zubehör</i> Support accessoires divers	18 - 21
Toolbox and netbox <i>Werkzeugkasten und Netzbox</i> Coffre à outils et panier à filet	22
Vision solution <i>Vision lösung</i> Solution rétrovision	24 - 25
PALFINGER marking – speed limit <i>PALFINGER Beschilderung – Speedschild</i> Marquage PALFINGER – disque de vitesse	26
Tools support <i>Werkzeuge Halter</i> Support outillage	27
Screws and nuts <i>Schrauben und muttern</i> Vis et écrous	28

Hookloader installation / Abrollkipper Aufbau / Installation bras

Back cab platform <i>Frontbrücke</i> Passerelle dos cabine	30
Tarp system Palcover H <i>Planensysteme Palcover H</i> Système de bâchage Palcover H	31
Cab control kit <i>Kabinnensteuerungssatz</i> Kit commande cabine	32
Container support <i>Container auflager</i> Sellettes	33
SAM advantages <i>SAM Vorteile</i> Avantages SAM	34 - 35
Interface hookloader / crane <i>Abrollkipper-Krananschluss</i> Interface bras / grue	36 - 37

Subframe extension <i>Unterrahmensverlängerung</i> Rallonge faux châssis	38
Stabilizer <i>Abstützung</i> Stabilisateur	39
Heavy range mounting kit 13-30 t <i>Schwere Reihe Montage Bausatz 13-30 t</i> Gamme lourde kit de fixation 13-30 t	41 - 50
PH T SCAN mounting kit <i>PH T SCAN Montage Bausatz</i> PH T SCAN Kit fixation	51 - 56
Middle range mounting kit 5-8 t <i>Mittel Reihe Montage Bausatz 5-8 t</i> Gamme moyenne kit de fixation 5-8 t	57 - 70
CiTy Mounting kit <i>CiTy Montagebausatz</i> CiTy Kit fixation	71 - 84
Miscellaneous <i>Sonstiges</i> Divers	85 - 86

Skiploader installation / Absetzkipper Aufbau / Installation multibenne

Tarp system Palcover S <i>Planensysteme Palcover S</i> Système de bâchage Palcover S	88
PS Mounting kit <i>PS Montagebausatz</i> PS Kit fixation	90 - 96

Retrofit kits / Nachrüstungssätze / Kits rétrofit

Retrofit kits for hookloader <i>Nachrüstungssätze für Abrollkipper</i> Kits rétrofit pour bras	98 - 100
Retrofit kits for skiploader <i>Nachrüstungssätze für Absetzkipper</i> Kits rétrofit pour multibenne	101 - 103

Legend / Legende / Légende



Bolts not included
Schrauben nicht enthalten
Visserie non incluse

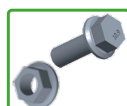

Bolts included
Schrauben enthalten
Visserie incluse

Additional information / weitere Informationen / Informations complémentaires

All certificates available in Paldesk <i>Prüfzeugnisse verfügbar im Paldesk</i> Certificats disponibles sur Paldesk	PALDESK/Products/Service/Hooklift Europe/Certificates
Mounting instructions available in Paldesk <i>Montageleistungen verfügbar im Paldesk</i> Instructions de montage disponibles sur Paldesk	PALDESK/Products/Service/Hooklift Europe/Installation guidelines

TANK

TANK

RÉSERVOIR

SELECTION / Auswahl / Sélection



Range Reichweite Gamme (t)	Rated oil flow / Ölmenge / Débit d'huile			Tank size Tank Grösse Taille réservoir (l)
	SDM 110 Q (l/min)	SDS150 Q (l/min)	SDS 180 Q (l/min)	
<3	10 - 12	-	-	20
5	25	-	-	30 - 50
7 - 8	30	40	-	30 - 50
10	-	40	-	50 - 75
12 - 15	-	50-60	-	75 - 100
17 - 30	-	60-80	80-100	120 - 200



14-18	-	80	95	120
-------	---	----	----	-----

* valid with PTO ratio close to 1 and RPM 1000tr/min/ gilt für Übersetzungsverhältnis des Nebenabtriebs von ca. 1 : 1 und RPM 1000 tr/min / valable avec rapport de prise mouvement proche de 1et un RPM de 1000 tr/min

Attention: Adapt the selection of pumps and tanks to vehicles and conditions of use. / Achtung: Die Größe der Pumpe bzw. des Hydrauliktanks müssen auf die jeweiligen Fahrzeuge und Einsatzbedingungen abgestimmt werden. / Attention: Adapter le choix des pompes et réservoirs aux véhicules et aux conditions d'utilisation.

CONTENT / Inhalt / Composition

- (1) Tank / Tank / Réservoir
- (2-3) Set of coupling / Verschraubungen / Réservoir
- (4) Stop valve / Absperrhahn / Vanne ¼ tour
- (5) Clamps / Schelle / Colliers

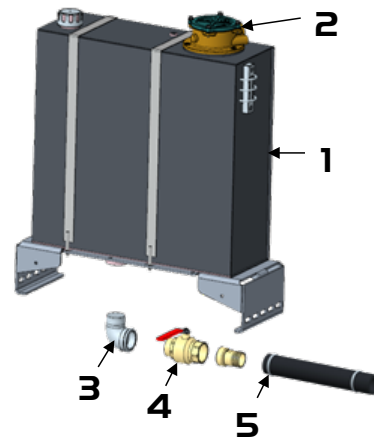

* Hoses are not supplied in the kit.

Schläuche sind nicht im Lieferumfang des Bausatzes enthalten.

Les flexibles ne sont pas fournis.

SUCTION HOSES / Saugschlauch / Durite d'aspiration

Reference Teil Nummer Référence	Ø ["]	ID / OD (mm)	Length [m] Länge Longueur
M63030897	1"	25 / 35	25
M63031144	1" 1/2	38 / 48	25
M63030898	2"	51 / 65	20
M63031247	2" 1/2	63 / 70	20



TANK FOR CITY / Tank für City / Réservoir pour City

	Tank kit Bausatz Tank Kit réservoir	Reference kit Teil Nummer Bau- satz Référence Kit	A [mm]	B [mm]	C [mm]	Tank only Tank alleine Réservoir seul	Suction Diam. Saugdurch. Diam. aspiration	Return fitting Rückverschraubung Raccord retour	kg
	20 L (≤ 4 t)	M2375139	238	420	420	M63050107	1"	16 S	7

To order separately
separat zu bestellen
A commander séparément

Tank support
Halter für Tank
Support réservoir

View

M9000567



Short support



M9000568



Long support



TANK FOR PH T05 / Tank für PH T 05 / Réservoir pour PH T 05

	Tank kit Bausatz Tank Kit réservoir	Reference kit Teil Nummer Bau- satz Référence Kit	A [mm]	B [mm]	C [mm]	Tank only Tank alleine Réservoir seul	Suction Diam. Saugdurch. Diam. aspiration	Return fitting Rückverschraubung Raccord retour	kg
	30 L (≤ 5 t)	M2372020	308	420	420	M63050531	1"	16 S	21

To order separately
separat zu bestellen
A commander séparément

Tank support
Halter für Tank
Support réservoir

M9000825



WHEELBASE MOUNTED TANKS / Tank im Radstand / Réservoirs dans l'empattement

	Tank kit Bausatz Tank Kit réservoir	Reference kit Teil Nummer Bau- satz Référence Kit	A [mm]	B [mm]	C [mm]	Tank only Tank alleine Réservoir seul	Suction Diam. Saugdurch. Diam. aspiration	Return fitting Rückverschraubung Raccord retour	kg
	50 L (≥ 5 t)	M2371057	410	580	580	M63050533	1 1/2"	22 L	30
	75 L (≥ 5 t)	M2371056	590	580	580	M63050534	2"	28 L	37
	100 L (≥ 5 t)	M2371055	560	810	480	M63050535	2"	28 L	43
	130 L (≥ 13 t)	M2371863	397	703	733	M63050516	2"	28 L	55
		M2375265							
	140 L (≥ 13 t)	M2371204	510	710	680	M63050043	2"	28 L	61
		M2375267							
	200 L (≥ 13 t)	M2371094	700	700	670	M63050063	2"	28 L	69
		M2375266							

To order separately
separat zu bestellen
A commander séparément

Tank support
Halter für Tank
Support réservoir

Quantity
Menge
Quantité

View

M9000482



<100L
x1

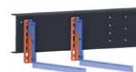

>130L
x2



General accessories
Allgemeines Zubehör
Accessoires généraux

Hookloader
Abrollkipper
Polybenne

Skiploader
Absetzkipper
Multibenne

Retrofit kits
Nachrüstungssätze
Kits rétrofit

TANK

TANK

RÉSERVOIR

REAR CAB MOUNTED TANK / Hinter-Fahrerhaus Tank / Réservoir dos cabine

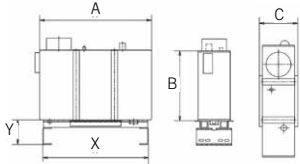

Tank kit Bausatz Tank Kit réservoir	Reference kit Teil Nummer Bau- satz Référence Kit	A [mm]	B [mm]	C [mm]	X [mm]	Y [mm]	Tank only Tank alleine Réservoir seul	Suction Diam. Saugdurch. Diam. aspiration	Return fitting Rückverschrau- bung Raccord retour	kg
narrow / schmal / étroit 120 L (≥ 13 t) + support / Halter / support	M2372021	722	706	276	828	174	M63050532	2"	28 L	65
120 L (≥ 13 t) + support / Halter / support	M2371731	880	552	294	828	234	M63050512	2"	28 L	65
200 L (≥ 13 t) + support / Halter / support	M2371864	880	924	304	828	234	M63050517	2"	28 L	75

To order separately
separat zu bestellen
A commander séparément

Tank support
Halter für Tank
Support réservoir

Quantity
Menge
Quantité

M9000701



30

HIGH PRESSURE FILTER / Hochdruckfilter / Filtre haute pression

Designation / Bezeichnung / Désignation

Reference
Teil Nummer
Référence

P max

Q max

kg

High pressure filter kit / Hochdruckfilter Bausatz /
Kit filtre haute pression

M2375346

365 bar

110L/min

11

NEW!

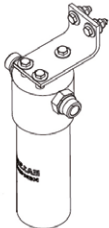

PISTON PUMPS / Kolbenpumpe / Pompes à pistons



Pump kit <i>Bausatz Pumpe</i> Kit Pompe	Reference <i>Referenz</i> Référence	Standard <i>Norm</i> Norme	Displacement <i>Volumen</i> Cylindrée [cm ³ /tr]	Coupling <i>Verschraubung</i> Raccords		kg	Pump alone <i>Pumpe alleine</i> Pompe seule
				Suction <i>Rücklauf</i> Aspiration	Pressure <i>Druck</i> Pression		
PA 25	M2371172	DIN 5462	28	2"	3/4"	17	M63060909
PA 32	M2371234	DIN 5462	34	2"	3/4"	17	M63060910
PA 40	M2371233	DIN 5462	43	2"	3/4"	17	M63060911
PA 50	M2371239	DIN 5462	50	2"	3/4"	17	M63060912
PAC 65	M2371101	DIN 5462	68	2"	3/4"	19	M63060932
PAC 80	M2371102	DIN 5462	78	2"	3/4"	19	M63060931
PAC 2x40	M2371236	DIN 5462	2x39	2"	3/4"	19	M63060935
PA 2x57	M2371200	DIN 5462	2x57	2"	3/4"	20	M63060924
XPi 18	M2372022	DIN 5462	18	1 1/2"	3/4"	11	M63061198
XPi 50	M2371733	DIN 5462	50	1 1/2"	3/4"	12	M63061225
XPi 63	M2371732	DIN 5462	63	2"	3/4"	12	M63060938
XPi 80	M2371310	DIN 5462	80	2"	1"	18	M63060937
XPi 108	M2371305 M2375262	DIN 5462	108	2" 2 1/2"	1"	18	M63060936 M63061230
XPi 130	M2372069 M2375263	DIN 5462	130	2" 2 1/2"	1"	-	M63061222 M63061231
By-pass kit							
By-pass XPi 18 - 63 24 V	M2375301	-	-	-	-	-	M63060940
By-pass XPi 80 - 130 24 V	M2375302	-	-	-	-	-	M63060941





LOW NOISE PUMP FOR ePTO / Leise Pumpe für ePTO / Pompe bruit réduit pour ePTO



XRE 41	M2375348	DIN 5462	41	2"	3/4"	18	-
--------	----------	----------	----	----	------	----	---

NEW!

	Pump kit Bausatz Pumpe Kit Pompe	Reference Referenz Référence	Standard Norm Norme	Displacement Volumen Cylindrée [cm³/tr]	Coupling Verschraubung Raccords		kg	Pump alone Pumpe alleine Pompe seule
					Suction Rücklauf Aspiration	Pression Druck Pression		
	A17FO 45	M2371699	DIN 5462	45	2"	3/4"	8	M63061136
	A17FO 63	M2371700	DIN 5462	63	2"	3/4"	9	M63061137
	A17FO 80	M2371701	DIN 5462	80	2"	3/4"	11,6	M63061138
	A17FO 107	M2371702 M2375264	DIN 5462	107	2" 2" 1/2	3/4"	14,5	M63061139
By-pass kit								
	By-pass A17FO 63 24 V	M2375303	-	-	-	-	-	M63061192
	By-pass A17FO 80 24 V	M2375304	-	-	-	-	-	M63061190
	By-pass A17FO 107 24 V	M2375305	-	-	-	-	-	M63061193

LOW NOISE PUMP FOR EPTO / Leise Pumpe für ePTO / Pompe bruit réduit pour ePTO



PGH4-40	M2375354	DIN 5462	40	2"	3/4"	18	-
---------	----------	----------	----	----	------	----	---

NEW!

Pmax 31.5MPa

GEAR PUMPS / Zahnpumpe / Pompes à engrenages



	Pump kit Bausatz Pumpe Kit Pompe	Reference Referenz Référence	Shaft Standard Welle Norm Norme Arbre	Displacement Volumen Cylindrée [cm³/tr]	Coupling Verschraubung Raccords		kg	Pump alone Pumpe alleine Pompe seule
					Suction Rücklauf Aspiration	Pression Druck Pression		
	NPLH UNI 13DIN 12	M2375307	UNI	11,92	1/2"	1/2"	5.14	-
	NPLH UNI 13DIN 16	M2375308	UNI	16,03	1/2"	1/2"	5.58	-
	NPLH UNI 13DIN 20	M2375309	UNI	20.1	1/2"	1/2"	5.84	-

Pmax 28MPa

2 WAYS VALVE FOR LS PUMP SHARING / 2 Wege Ventil für LS Pumpe Verteilung / Vanne 2 voies pour partage pompe LS

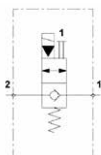

2 ways valve 24VDC	M2371771							
--------------------	----------	--	--	--	--	--	--	--

NEW!

UNDERRIDE PROTECTION

UNTERFAHRSCHUTZ

BARRE ANTI-ENCASTREMENT

Conform to 58R03

URP brackets / UFS Montagekonsolen / Flasques BAE

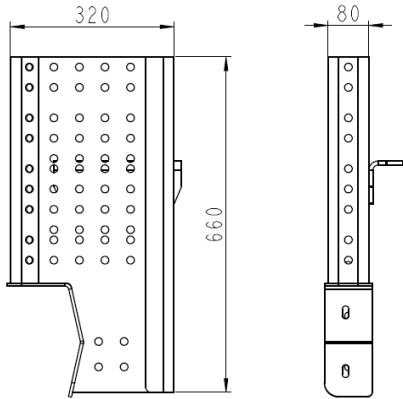

URP Brackets UFS Montagekonsolen Flasques BAE	Reference Teil Nummer Référence	kg
Not drilled / Ungebohrt / Non percées Other brands / Andere Marken / Autres marques DAF CF - XF	M9001117	44
RENAULT D>16T - D WIDE - T - C - K VOLVO FM(X) - FH	M9001040	44
MAN TGM - TGS - TGX	M9001039	43
MERCEDES AROCS - ANTOS - ACTROS	M9001041	43
IVECO SWAY - XWAY - TRAKKER	M9001042	43
SCANIA P - G - R	M9001043	43

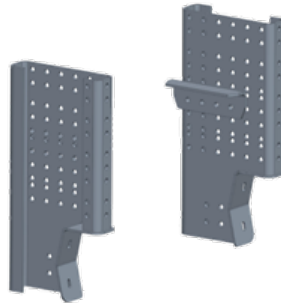

! Check compatibility with truck 16t>GVW>19t / Kompatibilität mit LKW prüfen 16t>LKW>19t / Vérifier la compatibilité avec les châssis 16t>PTAC>19t.

VALID FOR / GÜLTIG FÜR / VALABLE POUR :

Trucks category / LKW-Kategorie / Catégories de camion



GVW > 19t with bolts Ø14mm
ZGG >19t mit Schrauben Ø14mm
PTAC >19t avec boulons Ø14mm

TELESCOPIC URP (N3) / Teleskop UFS (N3) / BAE Télescopique (N3)

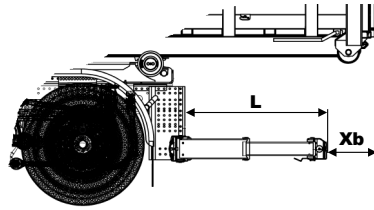

TELESCOPIC HYDRAULIC OPERATED / Teleskop hydraulisch / Télescopique hydraulique (N3)

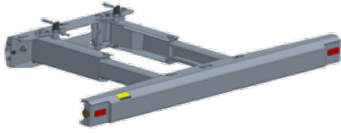

Designation Bezeichnung Désignation	L [mm]	Stroke [mm] Hub Course	Reference Teil Nummer Référence	Xb [mm]	kg
T-XL	1268	1055	M2093150	300	138
T-L	1068	855	M2093155	300	133
T-M	868	655	M2093155	300	129
T-S	568	355	M2093156	300	121



Hookloader option code / Abrollkipper Optionscode / Code option bras: 6707

TELESCOPIC MANUALLY OPERATED / Teleskop manuell / Télescopique manuelle (N3)

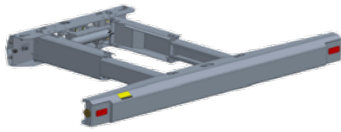

Designation Bezeichnung Désignation	L [mm]	Stroke [mm] Hub Course	Reference Teil Nummer Référence	Xb [mm]	kg
TM-XL	1268	1055	M2093152	300	122
TM-L	1068	855	M2093157	300	118
TM-M	868	655	M2093158	300	113
TM-S	568	355	M2093159	300	105



Hookloader option code / Abrollkipper Optionscode / Code option bras: 6712

ARTICULATED HYDRAULIC OPERATED / Klappbare hydraulisch / Articulée hydraulique (N3)

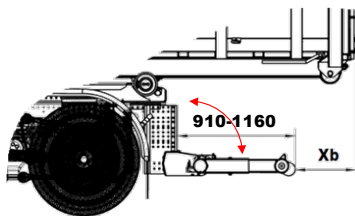

Designation Bezeichnung Désignation	Reference Teil Nummer Référence	Xb [mm]	kg
URP A UFS A BAE A	M2093147	300	185

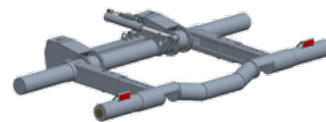

L out setting step / Einstellschritt / Pas de réglage: 50mm
Hookloader option code / Abrollkipper Optionscode / Code option bras: 6707

FIXED / Starr / Fixe (N3)

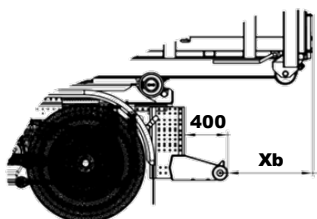

Designation Bezeichnung Désignation	Reference Teil Nummer Référence	Xb [mm]	kg
URP A UFS A BAE A	M2093151	300	70

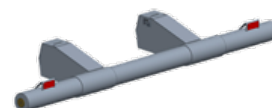

General accessories
Allgemeines Zubehör
Accessoires généraux

Hookloader
Abrollkipper
Polybenne

Skiploader
Absetzkipper
Multibenne

Retrofit kits
Nachrüstungssätze
Kits retrofit

SIDE PROTECTION

SEITENUNTERFAHRSCHUTZ

PARE-CYCLISTES





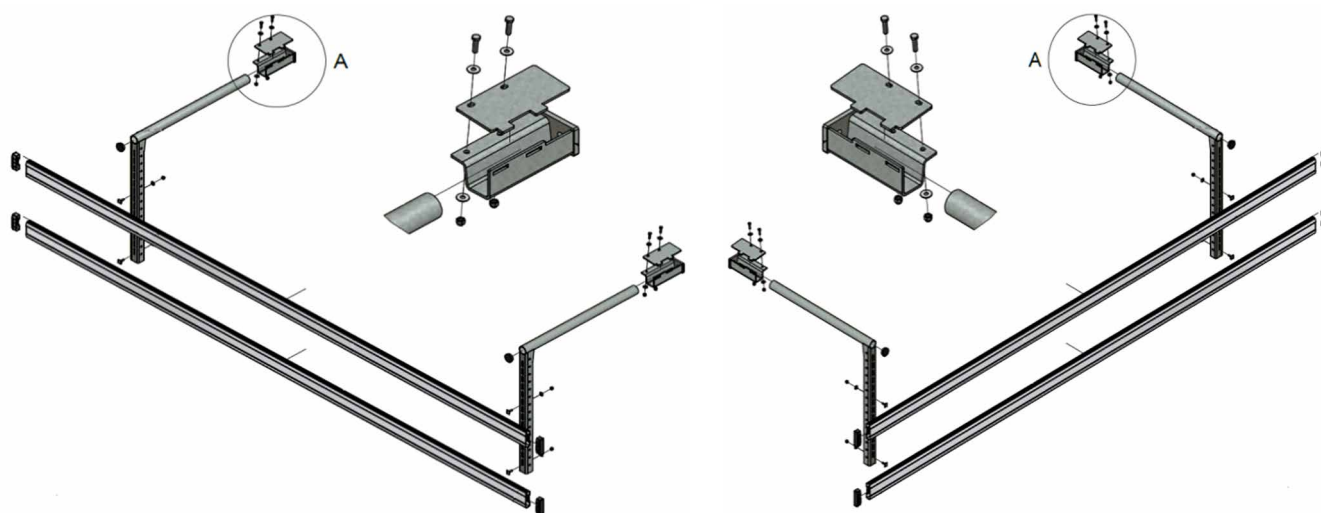
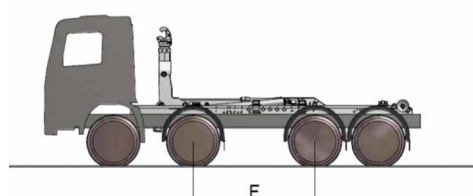
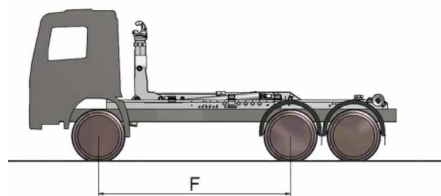

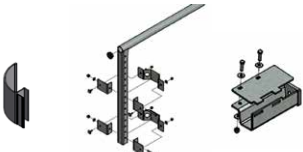

Conform to 73R01

KIT / Bausatz / Kit

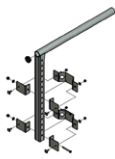
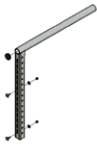

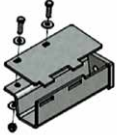
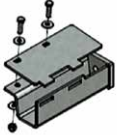
Designation / Bezeichnung / Désignation	Reference Teil Nummer Référence	F [mm]	kg
Kit 4 fixed supports + 4 aluminium profiles 3,5 m Bausatz 4 Halter + 4 Aluminium Profile 3,5 m Kit 4 supports fixes + 4 barres Alu 3,5 m	M9000400	3901 < F < 5000	60
Kit 4 fixed supports + 2 aluminum profiles 5 m Bausatz 4 Halter + 2 Aluminium Profile 5 m Kit 4 supports fixes + 2 barres aluminium 5 m	M9000401	F < 3900	73
Kit 6 fixed supports + 4 aluminium profiles 5 m Bausatz 6 Halter + 4 Aluminium Profile 5 m Kit 6 supports fixes + 4 barres aluminium 5 m	M9000402	F > 5000	126
Kit 4 fixed supports + 2 aluminium profiles 3,5 m Bausatz 4 Halter + 2 Aluminium Profile 3,5 m Kit 4 supports fixes + 2 barres aluminium 3,5 m	M9000403	PTAC < 8 t	47
Kit 4 fixed supports + 4 aluminium profiles 3,5 m black Bausatz 4 Halter + 4 Aluminium Profile 3,5 m schwarz Kit 4 supports fixes + 4 barres aluminium 3,5 m noir	M9000399	3901 < F < 5000	50

SINGLE PARTS / Einzelteile / Pièces détachées

	Designation / Bezeichnung / Désignation	Reference Teil Nummer Référence
	Kit 1 single support + accessories <i>Bausatz 1 Halter mit Zubehör</i> Kit 1 support unique + accessoires	M9000404
	Articulation kit for side protection <i>Bausatz klappbare seitliche Schutzvorrichtung</i> Kit articulation pare-cycliste	M9000405
	Angled bracket kit for extension <i>Bausatz Winkelhalter mit Schellen</i> Kit support coudé unique	M9000425
	Angled bracket kit <i>Bausatz Winkelhalter</i> Kit support coudé	M9000424
	Aluminium profile L3500 mm <i>Aluminium profil L3500 mm</i> Profil aluminium L3500 mm	M62010651
	Aluminium profile L5000 mm <i>Aluminium profil L5000 mm</i> Profil aluminium L5000 mm	M62010652
	Fixation bracket kit left <i>Bausatz Halter links</i> Kit support de fixation gauche	M9000423
	Fixation bracket kit right <i>Bausatz Halter rechts</i> Kit support de fixation droit	M9000500
	Angle profile H100 mm, L100 mm <i>Winkelabschluss H100 mm, L100 mm</i> Profil d'angle H100 mm, L100 mm	M62010615
	Angle profile H100 mm, L500 mm <i>Winkelabschluss H100 mm, L500 mm</i> Profil d'angle H100 mm, L500 mm	M62010714
	Rear cap <i>Abschluss</i> Bouchon AR	M62010616

General accessories
 Allgemeines Zubehör
 Accessoires généraux

Hookloader
 Abrollkipper
 Polybenne

Skiploader
 Absetzkipper
 Multibenne

Retrofit kits
 Nachrüstungssätze
 Kits retrofit

MUDGUARDS







KOTFLÜGEL

AILES

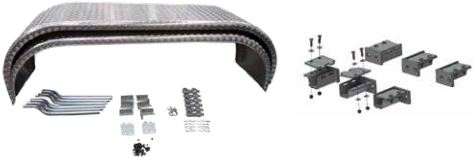
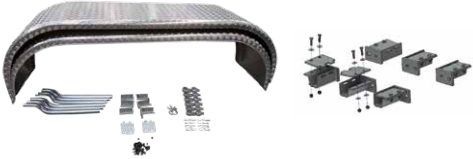
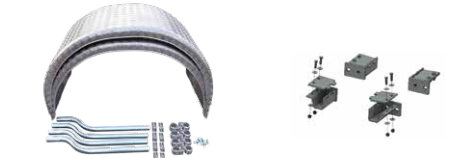
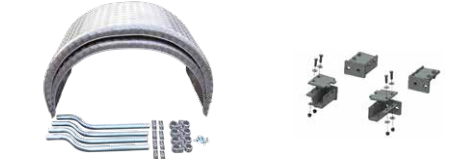
NEW!







The fixations are now part of the kits
Die Befestigungen sind dann Teil den Bausätze
Les fixations font maintenant partie du kit

KIT / Bausatz / Kit

	Designation Bezeichnung Désignation	Reference Teil Nummer Référence	Width [mm] Breite Largeur	Length [mm] Länge Longueur	kg
	2 axles aluminium mudguards kit with reflecting tape support <i>2 Achsen Alu-Kotflügel Bausatz mit Halterung für reflektiv Aufkleber</i> Kit ailes alu double essieux avec support pour bande réfléchissante	M9001355 NEW!	650	2700	60
	2 axles aluminium mudguards kit <i>2 Achsen Alu-Kotflügel Bausatz</i> Kit ailes alu double essieux	M9001375 NEW!	690	2700	60
	1 axle aluminium mudguards kit <i>1 Achse Alu-Kotflügel Bausatz</i> Kit ailes alu simple essieu	M9001356 NEW!	650	1280	46
	1 axle aluminium mudguards kit <i>1 Achse Alu-Kotflügel Bausatz</i> Kit ailes alu simple essieu	M9001357 NEW!	450	1350	45
	2 axles plastic mudguards kit <i>2 Achsen Plastik-Kotflügel Bausatz</i> Kit ailes plastique double essieux	M9001358 NEW!	650	2700	77
	1 axle plastic adjustable mudguards kit <i>1 Achse Plastic einstellbare Kotflügel Bausatz</i> Kit ailes plastiques ajustables simple essieu	M9001359 NEW!	650	1280	56
	Twin tire plastic mudguards kit <i>Zwillingsreifen Plastik-Kotflügel Bausatz</i> Kit ailes plastique monte jumelée	M9001363 NEW!	580	1285 GWV 8-10 t	54
	Twin tire plastic mudguards kit <i>Zwillingsreifen Plastik-Kotflügel Bausatz</i> Kit ailes plastique monte jumelée Ø 42 mm	M9001362 NEW!	530	1020 GWV 3,5-7,5 t 205-215/75/ R17,5	50
	Twin tire plastic mudguards kit <i>Zwillingsreifen Plastik-Kotflügel Bausatz</i> Kit ailes plastique monte jumelée Ø 36 mm	M9001361 NEW!	530	860 GWV 3,5-7,5 t 205-215/75/ R16	30
	Twin tire plastic mudguards kit <i>Zwillingsreifen Plastik-Kotflügel Bausatz</i> Kit ailes plastique monte jumelée Ø 36 mm	M9001360 NEW!	485	1020 GWV 3,5-7,5 t 205-215/75/ R14-16	32

Conform to 2011R0109

MUDFLAPS / Schmutzfänger / bavettes

Designation / Bezeichnung / Désignation	Reference Teil Nummer Référence	 [mm]	 kg
 <p>Aluminium separation & anti-spray mudflaps kit Aluminium Trennung mit Spritzlappen Bausatz Kit séparation aluminium avec bavettes anti-projection</p>	M9001364 NEW!	600x900	18,7
 <p>Separation & anti-spray mudflaps kit for PVC or alu fenders Trennung mit Spritzlappen Bausatz geeignet für PVC oder Alu Kotflügel Kit séparation avec bavettes anti-projection pour ailes PVC ou alu</p>	M9001241 NEW!	600x900	8,8
 <p>Anti-spray mudflaps kit Anti-spray Spritzlappen Bausatz Kit bavette anti-projection</p>	M9000761	600x900	7
 <p>Anti-spray mudflaps kit Anti-spray Spritzlappen Bausatz Kit bavette anti-projection</p>	M9000762	400x700	6

MUDFLAPS / Schmutzfänger / bavettes



<p>Slick mudflaps kit Spritzlappen Bausatz Kit bavette lisse</p>	M9000705	600x400	3
---	-----------------	---------	---

TUBE BRACKETS / Rohrhalterungen / Fixations tube

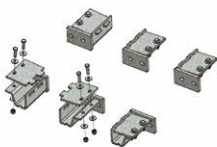

<p>Tube brackets kit (Tandem right & left) Rohrhalterungen Bausatz (Tandem rechts & links) Kit fixations pour tube (Tandem droite et gauche)</p>	M9800214	Ø42	9
---	-----------------	-----	---

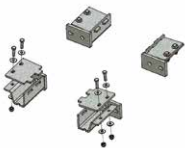

<p>Tube brackets kit (single fender right & left) Rohrhalterungen Bausatz (Einzel Kotflügel rechts & links) Kit fixations pour tube (Aile simple droite et gauche)</p>	M9800213	Ø42	6
---	-----------------	-----	---

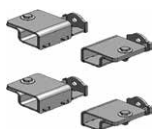

<p>Tube brackets kit (single fender right & left) Rohrhalterungen Bausatz (Einzel Kotflügel rechts & links) Kit fixations pour tube (Aile simple droite et gauche)</p>	M9000566	Ø34	2,3
---	-----------------	-----	-----

General accessories
Allgemeines Zubehör
Accessoires généraux

Hookloader
Abrollkipper
Polybenne

Skiploader
Absetzkipper
Multibenne









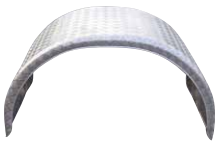

Retrofit kits
Nachrüstungssätze
Kits rétrofit

MUDGUARDS

KOTFLÜGEL

AILES

RETAILED MUD GUARDS / Einzelkotflügel / Ailes au détail

	Designation Bezeichnung Désignation	Reference Teil Nummer Référence	Width [mm] Breite Largeur	Length [mm] Länge Longueur	kg
	2 axles aluminium mudguard with reflecting tape support <i>2 Achsen Alu-Kotflügel für reflektiv Aufkleber</i> Aile alu double essieu avec support pour bande réfléchissante	M62010621 NEW!	650	2700	20
	2 axles aluminium mudguard <i>2 Achsen Alu-Kotflügel</i> Aile alu double essieux	M62010832 NEW!	690	2700	22
	1 axle aluminium mudguard <i>1 Achse Alu-Kotflügel</i> Aile alu simple essieu	M62010622	650	1280	12,5
 For / Für / Pour 8X4	1 axle aluminium mudguard <i>1 Achse Alu-Kotflügel</i> Aile alu simple essieu	M62010723	450	1280	12
	2 axles plastic mudguard <i>2 Achsen Plastik-Kotflügel</i> Aile plastique double essieux	M62010736	650	2700	11
	1 axle plastic adjustable mudguard <i>1 Achse einstellbare Plastik-Kotflügel</i> Aile plastique ajustable simple essieu	M62010179	650	1280	5
	Twin tire plastic mudguard <i>1 Achse Plastic Kotflügel</i> Aile plastique simple essieu	M62010947 NEW!	580	1285 GWV 8-10 t	6
	Twin tire plastic mudguard <i>Zwillingsreifen Plastik-Kotflügel</i> Aile plastique monte jumelée	M62010946 NEW!	530	1020 GWV 3,5-7,5 t 205-215/75/ R17,5	6
	Twin tire plastic mudguard <i>Zwillingsreifen Plastik-Kotflügel</i> Aile plastique monte jumelée	M62010857	530	860 GWV 3,5-7,5 t 205-215/75/ R16	2,5
	Twin tire plastic mudguard <i>Zwillingsreifen Plastik-Kotflügel</i> Aile plastique monte jumelée	M62010888	485	1020 GWV 3,5-7,5 t 205-215/75/ R14-16	6

KIT / Bausatz / Kit

Designation / Bezeichnung / Désignation

Reference
Teil Nummer
Référence



Tube mounting kit for aluminium mudguard Ø 42

Bausatz Halterrohr für Aluminium-Kotflügel Ø 42
KIT tube de fixation pour aile aluminium Ø 42

M9000501

2,5

Tube mounting kit for adjustable plastic mudguard Ø42

Bausatz Halterrohr für einstellbare Plastik-Kotflügel Ø42
Kit tube fixation aile plastique réglable Ø42

M9000502

2,6

Tube mounting kit for plastic mudguard Ø42

Bausatz Halterrohr für Plastik-Kotflügel Ø42
Kit tube fixation aile plastique Ø42

M9000692

NEW!

3

Mounting bracket - left Ø 42

Halter für Kotflügel - links Ø 42
Bride de fixation - gauche Ø 42

M9000503

1,6

Mounting bracket - right Ø 42

Halter für Kotflügel - rechts Ø 42
Bride de fixation - droite Ø 42

M9000504

1,6

Tube mounting kit for plastic mudguard Ø 34

Bausatz Halterrohr für Plastik-Kotflügel Ø 34
Kit tube de fixation pour aile plastique Ø 34

M9000833

1,8

Mounting bracket - left Ø 34

Halter für Kotflügel - links Ø 34
Bride de fixation - gauche Ø 34

M9000532

0,7

Mounting bracket - right Ø 34

Halter für Kotflügel - rechts Ø 34
Bride de fixation - droite Ø 34

M9000533

0,7

Aluminium corners kit for reflective tape

Aluminiumecke Bausatz für reflektierendes Klebeband
Kit cornières aluminium pour bande réfléchissante

M9001207

1

Rubber band for reflective tape on PVC mudguards

Gummiband für reflektiv Aufkleber am PVC Kotflügel
Bande Caoutchouc pour bande réfléchissante

M5333141

1

Aluminium corners kit for reflective tape

Aluminiumecke Bausatz für reflektierendes Klebeband
Kit cornières aluminium pour bande réfléchissante

M9001287

NEW!

4,6

For PHT05-HT07S-HT08 models

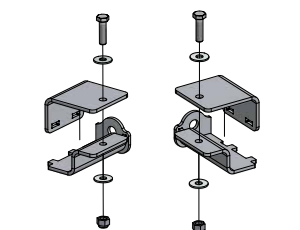
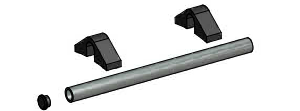
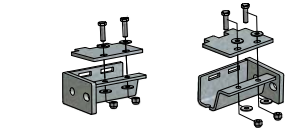
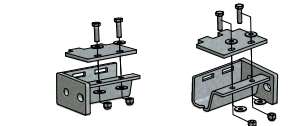

General accessories
Allgemeines Zubehör
Accessoires généraux

Hookloader
Abrollkipper
Polybenne







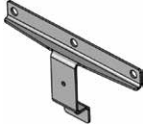

Skiploader
Absetzkipper
Multibenne

Retrofit kits
Nachrüstungssätze
Kits rétrofit

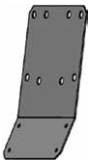
MOUNTING BRACKETS FOR ACCESSORIES

MONTAGEHALTER FÜR ZUBEHÖR SUPPORT ACCESSOIRES DIVERS

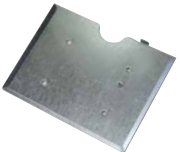
SUPPORT FOR ADR PLATE / Halter für ADR-Tafel / Support plaque ADR

Designation / Bezeichnung / Désignation			Reference Teil Nummer Référence
 	Side support for ADR plate <i>Halter seitlich für ADR-Tafel</i> Support latéral pour plaque ADR		M5331105_80036
 	Rear support for ADR plate <i>Halter hinten für ADR-Tafel</i> Support arrière pour plaque ADR		M5331628_80036
	ADR plate support lozenge <i>ADR-Tafelhalter rautenförmig</i> Support plaque ADR losange		M62010247
	ADR plate support rectangle <i>ADR-Tafelhalter rechteckig</i> Support plaque ADR rectangle		M62010248

SUPPORT FOR LOWER MAIN VALVE / Adapter Halter für niedrige Position des Steuerschiebers / Support distributeur surbaissé



Support for lower main valve (- 85mm)
Adapter für niedrige Steuerschieberposition (- 85mm)
 Support pour distributeur surbaissé (- 85mm)



M5328778_80030

* not needed on PHT / nicht notwendig am PHT / pas nécessaire sur les PHT

REAR HYDRAULIC CONNECTIONS SUPPORT / Bausatz Halter für hydraulische Anschlüsse / Support pour prises hydrauliques arrières



Rear hydraulic connections support
Bausatz-Halter für hydraulische Schnellkupplungen
 Support pour prises hydrauliques arrières



M5331627_80061

ELECTRIC CONNECTIONS SUPPORT / Halter für elektrische Anschlüsse / Support pour prises électriques arrières et mains d'air

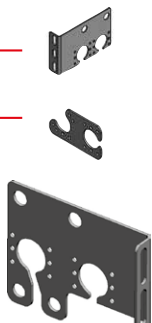

Designation / Bezeichnung / Désignation	Reference Teil Nummer Référence
 <p>Electric connections support Bausatz Halter E-Kupplung Support pour prises électriques et mains d'air</p>	M5331647_80061
 <p>Additional electric connection support Zusätzlicher Bausatz-Halter für E-Kupplung Support additionnel pour prise électrique</p>	M5332192_80061
<p>Additional hydraulic, electric and pneumatic connection support Zusätzliche hydraulische, elektrische und pneumatische Anschlüsse Support additionnel pour prise hydraulique, électrique et pneumatique</p>	M5337954_80061

REAR LIGHTS SUPPORT KIT / Rückleuchten Halterbausatz / Kit support de feux arrière

Designation / Bezeichnung / Désignation	Reference Teil Nummer Référence	kg
 <p>Rear light supports kit Rückleuchten-Halter Kit supports de feux AR</p>	M9000481	20

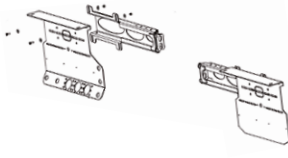

REAR LIGHTS SUPPORT KIT WITH TRAILER PLUGS IN LINE / Rückleuchten Halterbausatz mit Anhängerstecker in Line / Kit support de feux arrière avec coupleurs remorques alignés

 <p>Rear light supports for horizontal trailer plugs Bausatz Halter Rückleuchten für horizontale Anhängerkupplungen Kit support feux arrière pour prises remorque horizontales</p>	M9001291	19
 <p>Left rear light support for horizontal trailer plugs Halter Rückleuchten für horizontale Anhängerkupplung Support gauche feux arrière pour prises remorque horizontales</p>	M5340257_80061	6

NEW!

NEW!



REINFORCED REAR LIGHTS SUPPORT KIT / Verstärkter Rückleuchten Halterbausatz / Kit support de feux arrière renforcée

 <p>Reinforced rear light supports kit Verstärkter Halter Rückleuchten Bausatz Kit support feux arrière renforcées</p>	M9000656	26
--	-----------------	-----------



MOUNTING BRACKETS FOR ACCESSORIES

MONTAGEHALTER FÜR ZUBEHÖR SUPPORT ACCESSOIRES DIVERS

EXTINGUISHER AND WORKING LIGHTS SUPPORT / Halter für Feuerlöscher und Arbeitsscheinwerfer / Supports coffre extincteur et phare de travail

Designation / Bezeichnung / Désignation

Reference
Teil Nummer
Référence



**Support kit for extinguisher between single mudguard
(Palfinger tubes for mudguard are required)**

Halterbausatz für Feuerlöscher zwischen einzelne Kotflügel
(Palfinger Halterung für Kotflügel ist nötig)
Kit support extincteur entre ailes simples
(Le tube support Palfinger est nécessaire)

M9001328

NEW!

13,5

Zn Ni protected

For PHT-HT models

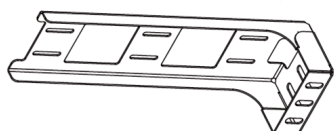

Vertical extinguisher support

Vertikal Halter für Feuerlöscher
Support extincteur vertical

M5339887_80030

NEW!

3,6

Zn Ni protected

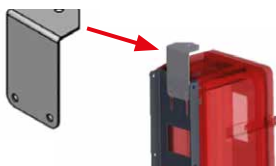

Worklight support for vertical position

Arbeitscheinwerfer Halter für vertikale Position
Support phare de travail pour position verticale

M5331980_80061

0,8

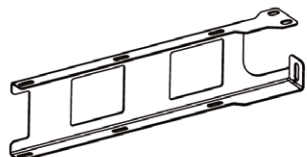

Horizontal extinguisher support

Horizontal Halter für Feuerlöscher
Support extincteur horizontal

M5340150_80030

NEW!

2,8

Zn Ni protected

For PHT-HT models

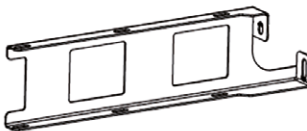

Horizontal extinguisher support

Horizontal Halter für Feuerlöscher
Support extincteur horizontal

M5340151_80030

NEW!

2,8

Zn Ni protected

For T-P-S models



**6 kg powder estinguisher class ABC
(Instructions in French)**

6 kg Pulver Feuerlöscher Klasse ABC
(Französische Anweisungen)
Extincteur 6 kg poudre classe ABC
(consignes en français)

M66000031

9



Plastic extinguisher box horizontal

Feuerlöscherkasten horizontal
Coffre extincteur plastique horizontal

M66000107

2,8





Plastic extinguisher box vertical

Feuerlöscherkasten vertikal
Coffre extincteur plastique vertical

M66000041

2,9



WATER TANK / Wassertank / Réservoir d'eau

Designation / Bezeichnung / Désignation	Reference Teil Nummer Référence	kg
 <p>30 L water tank kit (Fixation between mud guards) 30 L Wassertank Bausatz (Montiert zwischen Kotflügel) Kit réservoir d'eau 30 L (Montage entre ailes)</p> <p>Zn Ni protected</p>	<p>M9001336</p> <p>NEW!</p>	5,5
 <p>30L water tank kit (Fixation on frame) 30 L Wassertank (Montiert am Chassis) Kit réservoir d'eau 30 L (Montage sur châssis)</p> <p>Zn Ni protected</p> <p>Embedded soap dispenser / Inklusiv Seifenspender / Distributeur de savon intégré</p>	<p>M9001335</p> <p>NEW!</p>	5

ANGLE MORT WARNING / Angle Mort Warnungsschild / Avertisseur angle mort

Mandatory in France for all truck GVW above 3,5t
Pflicht im Frankreich für alle Fahrzeuge über 3,5t Gesamtgewicht
Obligatoire en France pour les camions avec PTC supérieur à 3,5t



Designation / Bezeichnung / Désignation	Reference Teil Nummer Référence	kg
 <p>Elbow support for "Angle mort" shield Winkel Halterung für « Angle mort » Schild Support angle mort en équerre</p>	<p>M5339084</p> <p>NEW!</p>	1,66
 <p>"Angle mort" Sticker « Angle Mort » Aufkleber Autocollant « Angle mort »</p>	<p>M62010911</p> <p>NEW!</p>	-

« A » SHIELD / « A » SCHILD / PANNEAU « A »

 <p>Vertical foldable support for "A" shield Vertikal klappbare Halterung für « A » Schild Support pliable vertical pour panneau « A »</p>	<p>M62010932</p> <p>NEW!</p>	0,5
---	-------------------------------------	-----

TOOLBOX AND NETBOX



WERKZEUGKASTEN UND NETZBOX

COFFRE À OUTILS ET PANIER À FILET

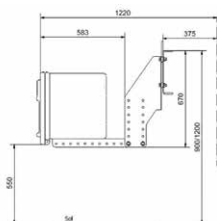
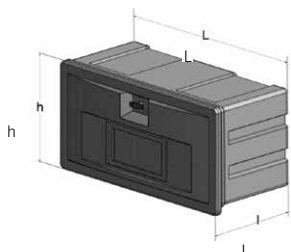

CONFORM TO ECE Regulation N°73R01

TOOLBOX / Werkzeugkasten / Coffre à outils

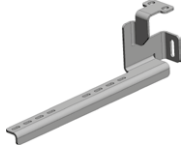

Designation / Bezeichnung / Désignation	Reference Teil Nummer Référence	L [mm]	I [mm]	h [mm]	kg
 Tool box support kit Halter Werkzeugkasten Kit support de coffre à outils	M9000498	-	-	-	19
	NEW!				
	M62010099	520	480	500	7
 Plastic toolbox Plastik Werkzeugkasten Coffre à outils plastique	M62010176	650	480	500	8
	M62010696	800	480	500	10
	M62010177	1000	480	500	12
 Black steel toolbox Schwarzer Stahlwerkzeugkasten Coffre à outils acier noir	M62010815	600	400	500	22
	M62010813	800	500	500	31
	M62010814	1000	500	500	36

NETBOX / Netzbox / Panier à filet

Designation / Bezeichnung / Désignation	Reference Teil Nummer Référence	L [mm]	I [mm]	h [mm]	kg
T 13-15-26-30 P 14-24 S 14-21  Net box support Netzboxhalter Support panier à filet	M5331981_80036	-	-	-	3
PH T 18-24 HT 26-30 HT 07S-08  Net box support Netzboxhalter Support panier à filet	P HT 18-24: M5337503_80036 HT 26-30: M5340743_80036 HT 07S-08: M5341402_80036	-	-	-	3 3,2 2,4
 Netbox Netzbox Panier à filet réglable	M9000497	2* 900 3* 1200	480	180	16

* netbox support quantity needed / Menge an Netzboxhaltern erforderlich / quantité de supports nécessaire

SCREWS AND NUTS

SCHRAUBEN UND MUTTERN

VIS ET ÉCROUS

Use Medium thread locker

Verwenden Sie Medium Thread Locker
Utiliser du frein filet medium

Not included / Nicht enthalten / Non inclus



For threads up to and including M36 or G1"
Für Gewinde bis einschließlich M36 oder G1 "
Pour les filetages jusqu'à M36 ou G1 " inclus

SCREWS

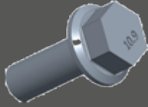
	Diameter Durchmesser Diamètre (mm)	Length Länge Longueur (mm)	Quality Qualität Qualité	Quantity per box Menge pro Box Quantité par boîte
M9000589	M10	40	10.9	25
M9000587	M12	40	10.9	25
M9001374	M14	30	10.9	25
M9000464	M14	40	10.9	50
M9000465	M14	50	10.9	50
M9001032	M14	80	10.9	25
M9001033	M14	100	10.9	25
M9000505	M16	50	10.9	50
M9000506	M16	60	10.9	50
M9001128	M16	80	10.9	25
M9001129	M16	100	10.9	25

NUTS

	Diameter Durchmesser Diamètre (mm)	Quality Qualität Qualité	Quantity per box Menge pro Box Quantité par boîte
M9000597	M10	10.9	25
M9000588	M12	10.9	25
M9000463	M14	10.9	50
M9000507	M16	10.9	50

General accessories
Allgemeines Zubehör
Accessoires généraux

Hookloader
Abrollkipper
Polybenne

Skiploader
Absetzkipper
Multibenne

Retrofit kits
Nachrüstungssätze
Kits rétrofit

VISION SOLUTION

VISION LÖSUNG



SOLUTION RÉTROVISION

CONFORM TO ECE R10

REAR VISION KIT / Rückkamera Bausatz / Kit Retrovision

View / Sicht / Vue	Designation / Bezeichnung / Désignation	Reference Teil Nummer Référence	Features Eigenschaften Caractéristiques
	Complete rear vision kit <i>Komplett Rückkamera Bausatz</i> Kit rétrovision complet	M9001198	7" screen definition 1024x600 - Dimension 180x121x24mm Voltage 12/24V Number of camera inputs: 4 Screen sharing function 1-2 or 4 cameras Delivered with 1 remote control, 1 camera & extension cable <i>7" Schirm Definition 1024x600 - Abmessungen 180x121x24mm - Spannung 12/24V</i> <i>Eingänge Zahl für Kamera: 4</i> <i>Schirm Verteilung Funktion 1-2 oder 4 Kameras</i> <i>Geliefert mit ein Fernsteuerung, 1 Kamera und Verlängerungskabel</i> Écran 7" définition 1024x600 - Dimension 180x121x24mm Voltage 12/24V Nombre d'entrées caméra: 4 Fonction partage écran 1-2 ou 4 caméras Livré avec télécommande, une camera et cable d'extension

CAMERA / Kamera / Caméra

	Camera <i>Kamera</i> Caméra	M65031222	HD 950x576 IP69K Video format PAL
	Camera extension cable 15m <i>Kamera Verlängerungskabel 15m</i> Câble d'extension caméra 15m	M4701236	GX12 connector

WORKING LIGHTS / Arbeitsscheinwerfer / Phare de travail

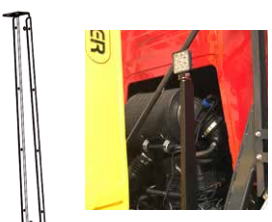
Designation / Bezeichnung / Désignation	Reference Teil Nummer Référence	kg
 Working light LED 1210 Lumens <i>Arbeitsscheinwerfer LED 1210 Lumens</i> Phare de travail à LED 1210 Lumens	M65031193	0,65
 Working light 24 V ADR 1400 Lumens <i>Arbeitsscheinwerfer 24 V ADR 1400 Lumens</i> Phare de travail 24 V ADR 1400 Lumens	M65030500	0,62
 Worklight and camera support <i>Arbeitsscheinwerfer und Kamera Halter</i> Support phare de travail et caméra	M5332091_80061	2,4



RAL 9005

VISION SOLUTION

VISION LÖSUNG





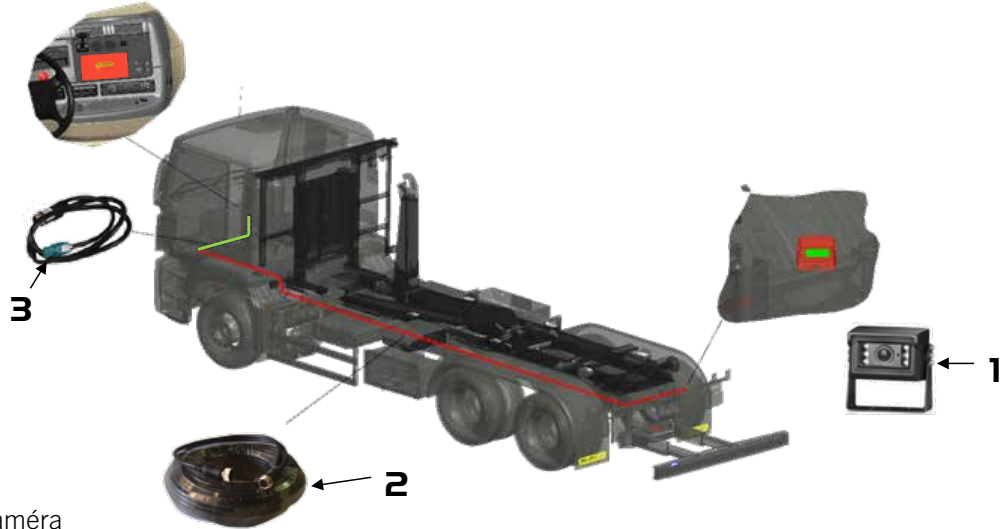

SOLUTION RETROVISION

TRUCK SCREEN ADAPTER KIT / LKW SCREEN Adapter Kit / Kit adaptation écran camion



COMPLETE KIT INCLUDES:

- (1) **Camera** / Kamera / Caméra
- (2) **Extension cable** / Verlängerungskabel / Câble d'extension
- (3) **Screen adapter** / Screen Schnittstelle / Adaptateur écran

	Application case <i>Anwendungsfall</i> Cas d'application	Truck option code <i>Optionscode</i> Code option	Reference <i>Teil Nummer</i> Référence
	T C K	1CY06	M9001191
	FL FE FH FM(X)	SID HIGH	M9001191
	MAN TG2	350NN	M9001194
 	Scania P & R MAN TG3	5120B 0P2MO	M9001197
	ATEGO ACTROS ANTOS AROCS	J9P J9J	M9001192 M9001196
	Eurocargo Stralis Trakker	7254 for HI CONNECT 2910 for IVECONNECT	M9001193 M9001195

General accessories
Allgemeines Zubehör
Accessoires généraux

Hookloader
Abrollkipper
Polybenne

Skiploader
Absetzkipper
Multibenne

Retrofit kits
Nachrüstungssätze
Kits rétrofit



PALFINGER MARKING – SPEED LIMIT

PALFINGER BESCHILDERUNG – SPEEDSCHILD

MARQUAGE PALFINGER – DISQUE DE VITESSE

CONFORM TO R104

PALFINGER REFLECTIVE TAPES / Reflexstreifen / Bandes réfléchissantes



	Designation / Bezeichnung / Désignation	Reference Teil Nummer Référence	 [m]
	Reflective tape YELLOW <i>Reflexstreifen GELB</i> Bande réfléchissante JAUNE	M62010722	50
	Reflective tape RED <i>Reflexstreifen ROT</i> Bande réfléchissante ROUGE	M62010724	50
	Reflective tape WHITE <i>Reflexstreifen WEISS</i> Bande réfléchissante BLANCHE	M62010725	50

PALFINGER branded
PALFINGER markiert
Marquage PALFINGER

CONFORM TO TPESC B 14038

	Alternating Reflective tape left & right RED/WHITE <i>Abwechselndes Reflexstreifen links & rechts ROT / WEISS</i> Bande réfléchissante alternée gauche et droite BLANC/ROUGE	M62010697	10
---	---	-----------	----

PALFINGER REFLECTIVE TAPES / Reflexstreifen / Bandes réfléchissantes



	Speed limit disc 80 km/h <i>Geschwindigkeitsschild 80 km/h</i> Disque limitation de vitesse 80 km/h	M62010088
	Speed limit disc 90 km/h <i>Geschwindigkeitsschild 90 km/h</i> Disque limitation de vitesse 90 km/h	M62010089
	Speed limit discs support <i>Geschwindigkeithalter</i> Support disques de vitesse	M9001349 NEW!

TOOLS SUPPORT

WERKZEUGE HALTER















SUPPORT OUTILLAGE

TOOLS SUPPORT / Werkzeuge Halter / Support outils



Designation / Bezeichnung / Désignation		Reference Teil Nummer Référence
 <p>Tool support (2 brackets with screws) Werkzeughalter mit Schrauben Support outils avec visserie</p>		<p>M9001334</p> <p>NEW!</p>

SIDE LIGHT SUPPORTS / Halter seitliche Leuchten / Supports de feux latéraux



Designation / Bezeichnung / Désignation		Reference Teil Nummer Référence			
   <p>Side light support SCANIA/VOLVO Halter seitliche Leuchten SCANIA/VOLVO Support feu latéral SCANIA/VOLVO</p>	  <p>Side light support MAN Halter seitliche Leuchten MAN Support feu latéral MAN</p>	   <p>Side light support RENAULT/MERCEDES Halter seitliche Leuchten RENAULT/MERCEDES Support feu latéral RENAULT/MERCEDES</p>	  <p>Side light support DAF Halter seitliche Leuchten DAF Support feu latéral DAF</p>	   	<p>M5319590_80036</p> <p>M5329924_80036</p> <p>M5317314_80036</p> <p>M5329925_80036</p>

SILENT MODE / Leise Modus / Mode silencieux

Designation / Bezeichnung / Désignation	Option code Optionscode Code option	Reference Teil Nummer Référence
 <p>Silent mode kit (middle position control box) Leise Modus Bausatz (Steuerblock in mittel Position) Kit mode silencieux (Boitier distributeur milieu)</p>	8201	<p>M9001373</p> <p>NEW!</p>
 <p>Silent mode kit (vertical position control box) Leise Modus Bausatz (Steuerblock in vertikale Position) Kit mode silencieux (Boitier distributeur vertical)</p>	8201	<p>M9001372</p> <p>NEW!</p>

NOTES
NOTIZEN
REMARQUES

Blank lined area for notes, consisting of 28 horizontal lines.

HOOKLOADER INSTALLATION

ABROLLKIPPER AUFBAU INSTALLATION BRAS



General accessories
Allgemeines Zubehör
Accessoires généraux

Hookloader
Abrollkipper
Polybenne

Skiploader
Absetzkipper
Multibenne

Retrofit kits
Nachrüstungssätze
Kits retrofit

BACK CAB PLATFORM

FRONTBRÜCKE

PASSERELLE DOS CABINE

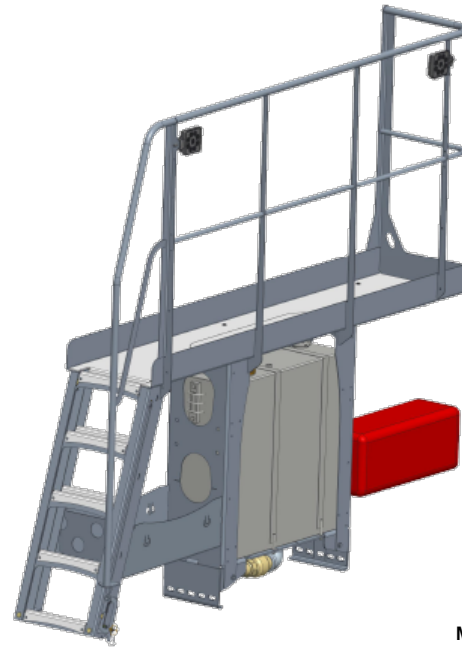

M9000823

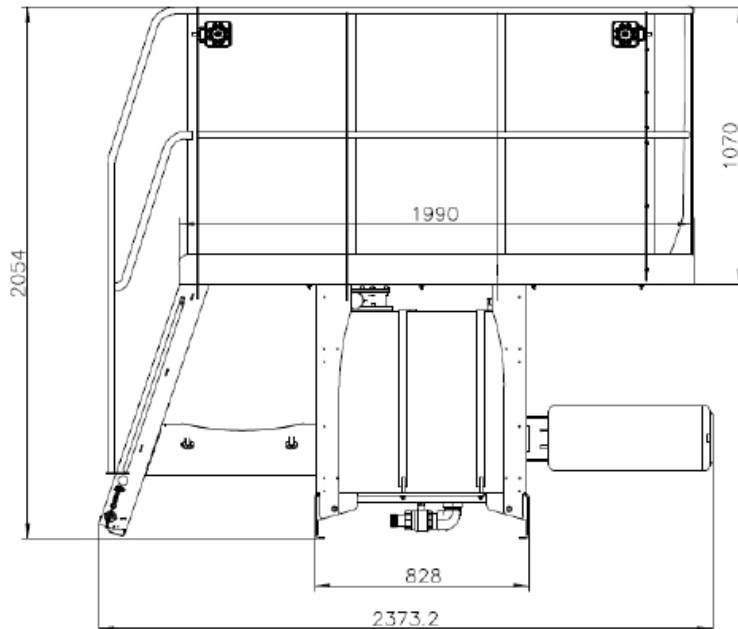

INCLUDED / Inhalt / Inclus

- **Tank 120 L & set of coupling**
Tank 120 L & Verschraubungen
Réservoir 120 L & Raccords d'aspiration
- **2 LED working light wired**
2 LED Arbeitsscheinwerfer (gekabelt)
2 phares à LED cablés
- **Secured extendable ladder**
Gesicherte einziehbare Leiter
Echelle rétractable sécurisée
- **Plastic extinguisher box**
Feuerlöscherkasten
Coffre à extincteur

Conform EN ISO 14122-3

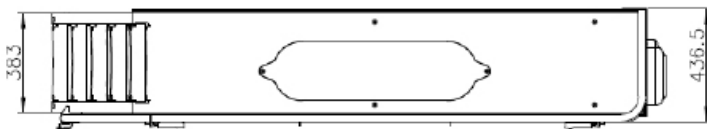

Designation / Bezeichnung / Désignation

Reference
Réferenz
Référence

Weight [kg]
Gewicht
Poids

Back cab platform
Fhs Rückwand Frontbrücke
Passerelle dos cabine







M9000823

235

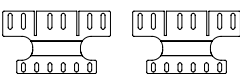

TARP SYSTEM PALCOVER H

PLANENSYSTEME PALCOVER H

SYSTÈME DE BÂCHAGE PALCOVER H

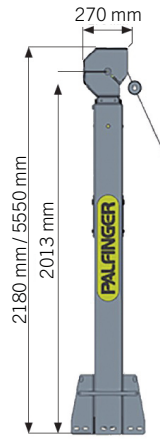
	Designation / Bezeichnung / Désignation	Reference Referenz Référence	Weight [kg] Gewicht Poids
PALCOVER H-E 	PALCOVER H-E with tarp - net with flaps <i>PALCOVER H-E mit Plane - Netz mit Laschen</i> PALCOVER H-E bâche filet avec rabats	M9000780	230
	PALCOVER H-E with tarp - net without flaps <i>PALCOVER H-E mit Plane - Netz ohne Laschen</i> PALCOVER H-E bâche filet sans rabats	M9000783	220
	PALCOVER H-E without tarp <i>PALCOVER H-E ohne Plane</i> PALCOVER H-E sans bâche	M9000785	205
PALCOVER H-M 	PALCOVER H-M with tarp - net with flaps <i>PALCOVER H-M mit Plane - Netz mit Laschen</i> PALCOVER H-M bâche filet avec rabats	M9000767	220
	PALCOVER H-M with tarp - net without flaps <i>PALCOVER H-M mit Plane - Netz ohne Laschen</i> PALCOVER H-M bâche filet sans rabats	M9000782	220
PALCOVER H-E fix 	PALCOVER H-E fix with tarp - net with flaps <i>PALCOVER H-E fix mit Plane - Netz mit Laschen</i> PALCOVER H-E fixe bâche filet avec rabats	M9000790	30
	Kit back cab. Tank 120 L + support for Palcover <i>Fhs Rückwand Tank 120 L + Halter für Palcover</i> Kit réservoir 120 L + support pour Palcover Narrow 120l tank included	M9001154	65
	Palcover height increasing spacer (+ 200mm) <i>Palcover Erhöhungsträger (+ 200mm)</i> Rehausse Palcover (+ 200mm) To be ordered by 2	M5335062_80036	4
	Palcover safety <i>Palcover Sicherheit</i> Sécurité stockage palcover Usefull to secure the hookloader operation	M9000881	1

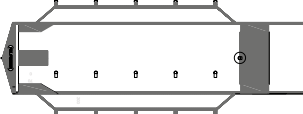

Single parts Einzelteile Pièces détachées	Designation / Bezeichnung / Désignation	Reference Referenz Référence	Weight [kg] Gewicht Poids
	RRC for PALCOVER H-E / S-E / SA-T <i>FFS für PALCOVER H-E / S-E / SA-T</i> Radio commande pour PALCOVER H-E / S-E / SA-T	M65031117	-
	Tarp - net with flaps <i>Plane - Netz mit Laschen</i> Bâche filet avec rabats	M2391004	15
	Tarp - net without flaps <i>Plane - Netz ohne Laschen</i> Bâche filet sans rabats	M2391009	12

General accessories
Allgemeines Zubehör
Accessoires généraux

Hookloader
Abrollkipper
Polybenne

Skiploader
Absetzkipper
Multibenne

Retrofit kits
Nachrüstungssätze
Kits rétrofit

CAB CONTROL KIT

KABINENSTEUERUNGSSATZ



KIT COMMANDE CABINE

PAD TOUCH SUPPORT / PAD TOUCH Halterung / Support PAD TOUCH

Designation Bezeichnung Désignation	Reference Teil Nummer Référence	Views Aussicht Vues
Ground TEC 5 cabin control support <i>Halter 1- TEC 5 Kabinensteuerung</i> Support commande cabine TEC 5 au sol	M2157002	
Multi-axis TEC 5 cabin control support <i>Multi-Axis TEC 5 Kabinensteuerung</i> Support multi- axes pour commande cabine TEC 5	M2157003	
Handrail TEC 5 cabin control support <i>Handrohr Halter - TEC 5 Kabinensteuerung</i> Support commande cabine TEC 5 pour main courante	M2157001	



LAYER SLD5 CONTROL / SLD5-Steuerungssymbole / Lexan commande SLD 5

Designation Bezeichnung Désignation	Unit type Gerätetyp Type d'équipement	Reference Teil Nummer Référence	Views Aussicht Vues
Layer SLD 5 without automatic mode right hand drive <i>SLD 5 Steuerungssymbole ohne Automatikmodus Rechtslenker</i> Lexan SLD 5 sans cycle automatique conduite à droite	CHEM / DINO unit	M62010890	
Layer SLD 5 with automatic mode right hand drive <i>SLD 5 Steuerungssymbole mit Automatikmodus Rechtslenker</i> Lexan SLD 5 avec cycle automatique conduite à droite		M62010891	

EXTENSION CAB CONTROL / Erweiterungskabinensteuerung / Câble extension cde cabine

Designation Bezeichnung Désignation	Reference Teil Nummer Référence	Views Aussicht Vues
SPIRAL CABLE M12 M-F 5 WIRES <i>SPIRALKABEL M12 M-F 5 KABEL</i> Câble spiralé M12 M-F 5 fils	M65031020	

CONTAINER SUPPORT

CONTAINER AUFLAGER

SELLETES

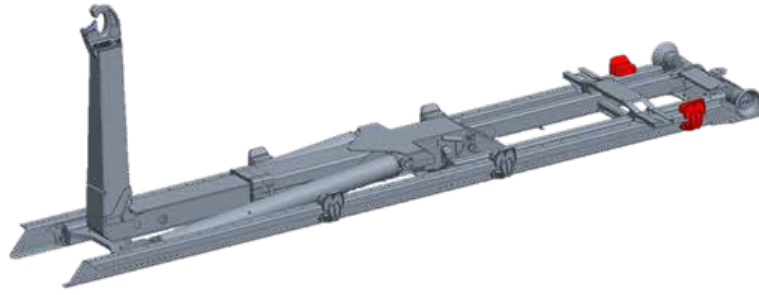

 **Single sold. Order by two / Einzel verkauft. Zu zwei bestellen / Vendue à l'unité. A commander par 2.**

ANTIFRICTION CONTAINER SUPPORT / Antifriction Container-Auflager / Sellettes antifriction

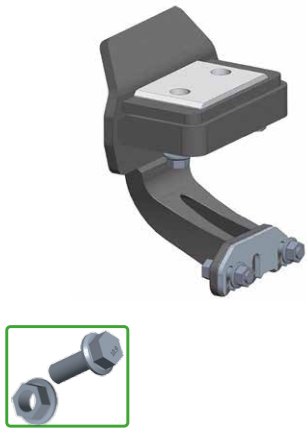

Designation Bezeichnung Désignation	Unit type Gerätetyp Type d'équipement	Finish Beschichtung Finition	Reference Teil Nummer Référence
Antifriction container support <i>Antifriction Container-Auflager geschraubt</i> Sellettes antifriction	PH T	RAL 9005	M2065781_R9005
Antifriction container support <i>Antifriction Container-Auflager geschraubt</i> Sellettes antifriction	PH T ACTS	RAL 9005	M2065786_R9005
Antifriction container support <i>Antifriction Container-Auflager geschraubt</i> Sellettes antifriction	PH T CHEM	RAL 9005	M2065800_R9005
Antifriction container support <i>Antifriction Container-Auflager geschraubt</i> Sellettes antifriction	PH T DINO	RAL 9005	M2065791_R9005

BOLTED CONTAINER SUPPORT / Container-Auflager geschraubt / Sellettes boulonnées



Designation Bezeichnung Désignation	Unit type Gerätetyp Type d'équipement	Finish Beschichtung Finition	Reference Teil Nummer Référence
Bolted container support <i>Container-Auflager geschraubt</i> Sellettes boulonnées	PH T	RAL 9005	M2065794_R9005
Bolted container support <i>Container-Auflager geschraubt</i> Sellettes boulonnées	PH T ACTS	RAL 9005	M2065795_R9005
Bolted container support <i>Container-Auflager geschraubt</i> Sellettes boulonnées	PH T CHEM	RAL 9005	M2065799_R9005
Bolted container support <i>Container-Auflager geschraubt</i> Sellettes boulonnées	PH T DINO	RAL 9005	M2065790_R9005

General accessories
Allgemeines Zubehör
Accessoires généraux

Hookloader
Abrollkipper
Polybenne

Skiploader
Absetzkipper
Multibenne

Retrofit kits
Nachrüstungssätze
Kits rétrofit

SAM ADVANTAGES

SAM VORTEILE AVANTAGES SAM

PH T 18-24



6x2 6x4 26-32 t



6x2 6x4 26-32 t

M9100046
SAM Advantage 26-32 t

M9100047
SAM Advantage Back cab

Designation / Bezeichnung / Désignation	Quantity Menge Quantité	Designation Bezeichnung Désignation	Quantity Menge Quantité	Designation Bezeichnung Désignation
Tank kit Bausatz Tank Kit réservoir	1	M2371863 130 L (≥ 13 t)	1	M2372021 vertical / vertikal / vertical 120 L (≥ 13 t) + support Halter / support
Tank support kit Halter für Hydrauliktank Kit support réservoir	1	M9000482	1	
Pump kit LEDUC Bausatz Pumpe LEDUC Kit pompe LEDUC	1	M2371310 XP80L (> 13 t) XPI 80 L	1	M2371310 XP80L (> 13 t) XPI 80 L
LED working light 1210 Lumens Arbeitscheinwerfer LED 1210 Lumens Phare de travail à LED 1210 Lumens	1	M65031193	1	M65031193
Working light support kit Halter für Arbeitscheinwerfer Kit support phare de travail	1	M5332091_80061 vertical / vertikal / vertical	1	M5331980_80061 for back cab extinguisher für vertikal Feuerlöscher pour extincteur dos cabine
Kit 4 supports + 4 aluminium profiles 3,5 m Bausatz 4 Halter + 4 Aluminium Profile 3,5 m Pare Cyclistes Kit 4 supp + 4 barres 3,5 m	1	M9000400	1	M9000400
ALU mudguards kit Bausatz Alu-Kotflügel Kit ailes ALU	1	M9000457 2 axles / 2 Achsen 2 essieux	1	M9000457 2 axles / 2 Achsen 2 essieux
Mudguards Fixation kit Bausatz Halter für Kotflügel Kit de fixation	1	M9800214 2 axles / 2 Achsen 2 essieux	1	M9800214 2 axles / 2 Achsen 2 essieux
Rear Light support kit Bausatz Halter Rückleuchten Kit support feux arrière	1	M9000481	1	M9000481
Netbox Netzkasten Panier à filet	1	M9000497	1	M9000497
Netbox support Netzboxhalter Support panier à filet	2	M5337503_80036	2	M5337503_80036
Plastic toolbox 650x500x480 Plastik Werkzeugkasten 650x500x480 Coffre à outils plastique 650x500x480	1	M62010176	1	M62010176
Toolbox support kit Halter Werkzeugkasten Kit support coffre à outils	1	M9000498	1	M9000498
Plastic extinguisher box Feuerlöscherkasten Coffre extincteur plastique	1	M66000107 horizontal	1	M66000041 vertical / vertikal / vertical
Support kit for extinguisher Halter Bausatz für Feuerlöscher Kit support extincteur	1	M5340150_80030 horizontal	1	M5339887_80030 vertical / vertikal / vertical

TELESCOPIC-POWER-SYNCHRON



4x2 4x4 19 t



6x2 6x4 26-32 t



6x2 6x4 26-32 t

M9100032
SAM Advantage 19 t

M9100033
SAM Advantage 26-32 t

M9100034
SAM Advantage Back cab

Designation / Bezeichnung / Désignation	Quantity Menge Quantité	Designation Bezeichnung Désignation	Quantity Menge Quantité	Designation Bezeichnung Désignation	Quantity Menge Quantité	Designation Bezeichnung Désignation
Tank kit Bausatz Tank Kit réservoir	1	M2371055 100L (≥ 5 t)	1	M2371863 130 L (≥ 13 t)	1	M2372021 vertical / vertikal / vertical 120L (≥ 13 t) + support Halter / support
Tank support kit Halter für Hydrauliktank Kit support réservoir	1	M9000482	1	M9000482		
Pump kit LEDUC Bausatz Pumpe LEDUC Kit pompe LEDUC	1	M2371732 XPI 63 (> 13 t)	1	M2371310 XPI 80 L (> 13 t)	1	M2371310 XPI 80 L (> 13 t)
LED working light 1210 Lumens Arbeitscheinwerfer LED 1210 Lumens Phare de travail à LED 1210 Lumens	1	M65031193	1	M65031193	1	M65031193
Working light support kit Halter für Arbeitscheinwerfer Kit support phare de travail	1	M5332091_80061 vertical / vertikal / vertical	1	M5332091_80061 vertical / vertikal / vertical	1	M5331980_80061 für back cab extinguisher für vertikal Feuerlöscher pour extincteur dos cabine
Kit 4 supports + 4 aluminium profiles 3,5 m Bausatz 4 Halter + 4 Aluminium Profile 3,5 m Pare Cyclistes Kit 4 supp + 4 barres 3,5 m	1	M9000400	1	M9000400	1	M9000400
ALU mudguards kit Bausatz Alu-Kotflügel Kit ailes ALU	1	M9000477 1 axle / 1 Achse / 1 essieu	1	M9000457 2 axles / 2 Achsen 2 essieux	1	M9000457 2 axles / 2 Achsen 2 essieux
Mudguards Fixation kit Bausatz Halter für Kotflügel Kit de fixation	1	M9800213 1 axle / 1 Achse / 1 essieu	1	M9800214 2 axles / 2 Achsen 2 essieux	1	M9800214 2 axles / 2 Achsen 2 essieux
Rear Light support kit Bausatz Halter Rückleuchten Kit support feux arrière	1	M9000481	1	M9000481	1	M9000481
Netbox Netzkasten Panier à filet	1	M9000497	1	M9000497	1	M9000497
Netbox support Netzboxhalter Support panier à filet	2	M5331981_80036	2	M5331981_80036	2	M5331981_80036
Plastic toolbox 650x500x480 Plastik Werkzeugkasten 650x500x480 Coffre à outils plastique 650x500x480	1	M62010176	1	M62010176	1	M62010176
Toolbox support kit Halter Werkzeugkasten Kit support coffre à outils	1	M9000498	1	M9000498	1	M9000498
Plastic extinguisher box Feuerlöscherkasten Coffre extincteur plastique	1	M66000107 horizontal	1	M66000107 horizontal	1	M66000041 vertical / vertikal / vertical
Support kit for extinguisher Halter Bausatz für Feuerlöscher Kit support extincteur	1	M9000496 horizontal	1	M9000496 horizontal	1	M9000495 vertical / vertikal / vertical

INTERFACE HOOKLOADER/CRANE

VORBEREITUNG - KRAMONTAGE

INTERFACE BRAS / GRUE

Not compatible with TEC cranes equipped with the new anti-rotation system.

Nicht kompatibel mit TEC-Kranen, die mit dem neuen Antirotationsystem ausgestattet sind.

Non compatible avec les grues TEC équipées du nouveau système anti-rotation.

Option : 9315 PK crane

Delivered with equipment
Mit Abrollkipper geliefert
Livré avec Bras

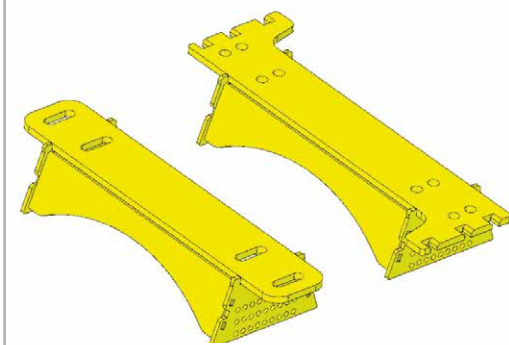





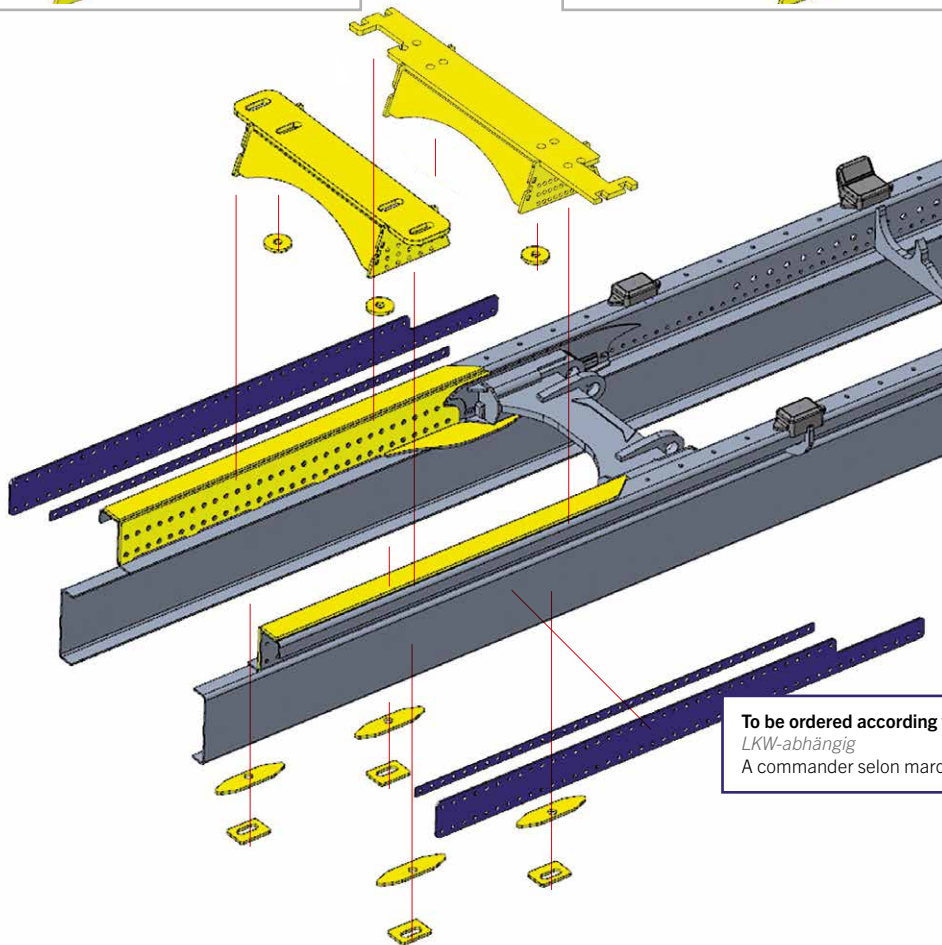
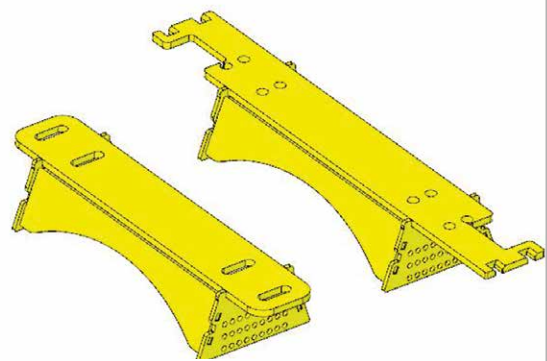



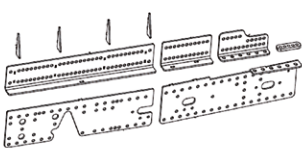

Option : 9314 EPSILON crane

Delivered with equipment
Mit Abrollkipper geliefert
Livré avec Bras

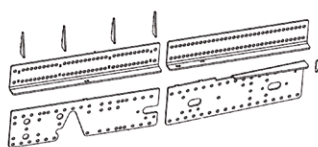

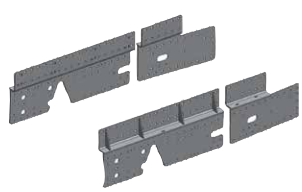
To be ordered according truck brand
LKW-abhängig
A commander selon marque camion

	Designation / Bezeichnung / Désignation	Reference Teil Nummer Référence	Finish Beschichtung Finition	Weight [kg] Gewicht Poids
  	KIT brackets for crane on RENAULT VOLVO <i>Kranmontageplatte für RENAULT VOLVO</i> Kit fixation grue RENAULT-VOLVO	M9000730	RVI 3650	38
 	KIT brackets for crane on MERCEDES air suspension <i>Kranmontageplatte für MERCEDES Luftfederung</i> Kit fixation grue MERCEDES suspension pneumatique	M9000728	primer grundiert en apprêt	71
 	KIT brackets for crane on MAN <i>Kranmontageplatte für MAN</i> Kit fixation grue sur MAN	T P S* M9000779	primer grundiert en apprêt	88
 	KIT brackets for crane on MAN <i>Kranmontageplatte für MAN</i> Kit fixation grue sur MAN	P H T M9000849	primer grundiert en apprêt	90
 	KIT brackets for crane on MAN SCAN <i>Kranmontageplatte für MAN SCAN</i> Kit fixation grue sur MAN SCAN	T SCAN P H T SCAN M9000781	primer grundiert en apprêt	67
	KIT brackets for crane UNIVERSAL <i>Kranmontageplatte UNIVERSAL</i> Kit fixation grue UNIVERSELLE	M9000729	primer grundiert en apprêt	42

* T P S: Telescopic Power Synchron

SUBFRAME EXTENSION

UNTERRAHMENVERLÄNGERUNG

RALLONGE FAUX CHÂSSIS

SUBFRAME EXTENSION KIT > 5 t / Bausatz Unterrahmenverlängerung > 5 t / Kit rallonge faux chassis > 5 t

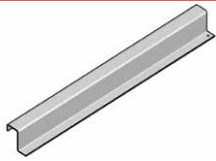

L = 2 m

primer
grundiert
en apprêt

Designation / Bezeichnung / Désignation	Reference Teil Nummer Référence	For unit Gerättyp Pour bras	Thickness [mm] Dicke Épaisseur	Weight [kg] Gewicht Poids
Subframe extension Unterrahmenverlängerung Rallonge Faux Châssis	M5328662	T07	5	20
	M5339738	HT 07S - HT 08	5	22
	M5328677	T13 - T15 - P14 - S14 - PH T 17SCAN	6	38
	M5328665	T18 - P17 - S17 - T20 (L ≤ 6000)	6	40
	M5328666	T20 (L ≥ 6150) - T22 - T24 - P20 - S21	8	52
	M5328667	HT 26 - HT 30 - T26 - T30 - P24	8	56
	M5328678	PH T 20 SCAN - PH T 22 SCAN - PH T 24 SCAN	8	49
	M5337848	PH T 18 - PH T 20	6	39
	M5337849	PH T 18 - PH T 20 - PH T 22 - PH T 24	8	51



SUBFRAME EXTENSION KIT FOR PH T 05 / Bausatz Unterrahmenverlängerung PH T 05 / Kit rallonge faux chassis PH T 05

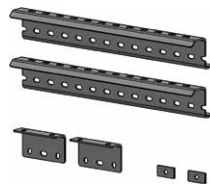
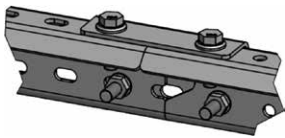

L = 1 m

RAL 7021

Designation / Bezeichnung / Désignation	Reference Teil Nummer Référence	Thickness [mm] Dicke Épaisseur	Weight [kg] Gewicht Poids
Subframe extension kit Bausatz Unterrahmenverlängerung Kit Rallonge Faux Châssis	M9000834	5	20



SUBFRAME EXTENSION KIT FOR CITY / Bausatz Unterrahmenverlängerung CITY / Kit rallonge faux chassis CITY

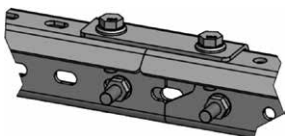

L = 650 mm

RAL 7021

Designation / Bezeichnung / Désignation	Reference Teil Nummer Référence	Thickness [mm] Dicke Épaisseur	Weight [kg] Gewicht Poids
Subframe extension kit Bausatz Unterrahmenverlängerung Kit Rallonge Faux Châssis	M9000659	4	9



STABILIZER

ABSTÜTZUNG

STABILISATEUR

AXLE STABILIZER / Achsabstützung / Blocage Essieu

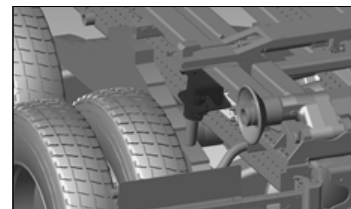
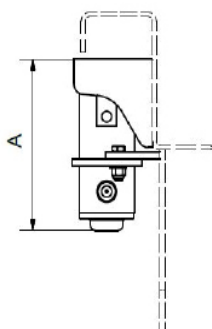
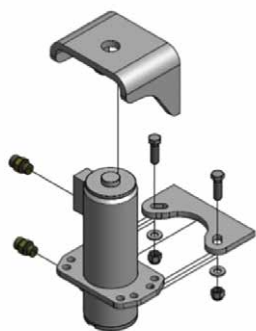

Designation / Bezeichnung / Désignation	Reference Teil Nummer Référence	A mini [mm] A mini Tige rentrée	A maxi [mm] A maxi Tige sortie	Weight [kg] Gewicht Poids
Short axle stabilizer kit Bausatz Achsabstützung kurz Kit blocage essieux court	M2371437	237	360	23,6
Long axle stabilizer kit Bausatz Achsabstützung lang Kit blocage essieu long	M2371445	287	460	25,6
Cylinder rod tip Plattfederschutz für Achsabstützung Embout de tige	M5116221	for Mercedes truck - sold by two für Mercedes-Fahrgestell - Verkauf im Zweierpack pour Châssis Mercedes - Vente par 2		

4401/4402/4403 * hookloader option required / Option für Abrollkipper erforderlich / option nécessaire sur le bras

ROLLER STABILIZER / Rollenabstützung / Rouleau anti-cabrage

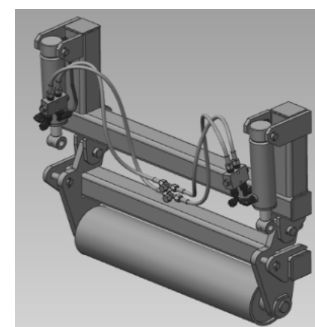
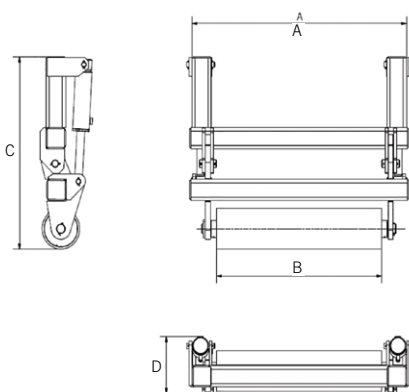

Designation / Bezeichnung / Désignation	Reference Teil Nummer Référence	For unit Gerättyp Pour bras	A [mm]	B [mm]	C [mm]	D [mm]	Weight [kg] Gewicht Poids
Rear roller stabilizer Bausatz Rollenabstützung Rouleau anti-cabrage	M2371438	≥ 13 t	900	410	846	256	90
	M2085021	(1150 mm) ≥ 13 t	1460	1150	916	268	215
	M2085023	(850 mm) ≥ 13 t	1160	850	916	268	185

4400 * hookloader option required / Option für Abrollkipper erforderlich / option nécessaire sur le bras

General accessories
Allgemeines Zubehör
Accessoires généraux

Hookloader
Abrollkipper
Polybenne

Skiploader
Absetzkipper
Multibenne

Retrofit kits
Nachrüstungssätze
Kits retrofit

HEAVY RANGE MOUNTING KIT 13-30 T

SCHWERE REIHE
MONTAGE BAUSATZ 13-30 T
GAMME LOURDE
KIT DE FIXATION 13-30 T



General accessories
Allgemeines Zubehör
Accessoires généraux

Hookloader
Abrollkipper
Polybenne

Skiploader
Absetzkipper
Multibenne

Retrofit kits
Nachrüstungssätze
Kits rétrofit

HEAVY RANGE MOUNTING KIT 13-30 T

SCHWERE REIHE MONTAGE BAUSATZ 13-30 T

GAMME LOURDE KIT DE FIXATION 13-30 T

RENAULT T-K-C / VOLVO FMX-FH-FM



Incompatible with option code **FRAME266**

Nicht kompatibel mit option code FRAME266.

Incompatible avec code option FRAME266.

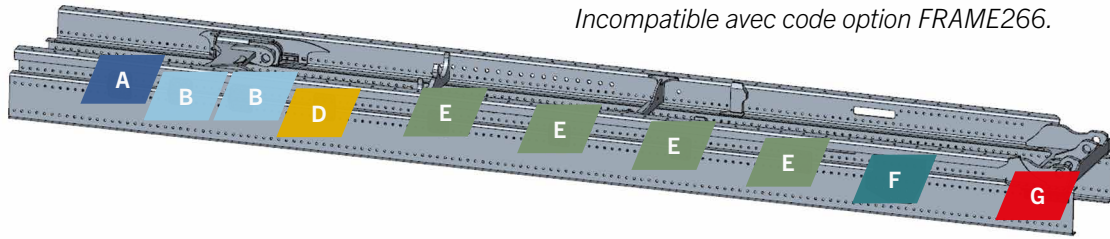

Diameter Durchmesser Diamètre (mm)	Length / Länge / Longueur (mm)					Nuts Nüsse Ecrus
	40	50	60	80	100	

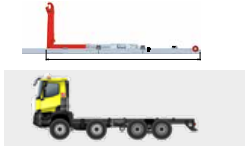

Ø14

M9000464
(qty 50/box)

M9000465
(qty 50/box)

-

M9001032
(qty 25/box)

M9001033
(qty 25/box)

M9000463
(qty 100/box)

PH T 18-24 - HT 26-30

	A	B	D	E	F	G	Bolts / Schrauben / Visserie
			-				
M9000955 < 5600 mm + screws / Schrauben / Visserie	x1	x2	-	x5	-	x1	
M9000973 ≥ 5600 mm + screws / Schrauben / Visserie	x1	x2	-	x6	-	x1	
M9000884 ≤ 5600 mm	x1	x2	-	x5	-	x1	
M9000885 > 5600 mm	x1	x2	-	x6	-	x1	
M9001011		x1 M9000730		x6		x1	
Retailed kits	M9000886	M9001155	-	M9000887	M9000947 [Ⓢ] M9000462 [Ⓢ]	M9000991	

TELESCOPIC T(A) 13-30 - POWER P(A) 14-24 - SYNCHRON S 14-21

	A	B	D	E	F	G	Bolts / Schrauben / Visserie
M9000956 < 5600 mm + screws / Schrauben / Visserie	x1	x2	x1	x4	-	x1	
M9000974 ≥ 5600 mm + screws / Schrauben / Visserie	x1	x2	x1	x5	-	x1	
M9000890 ≤ 5600 mm	x1	x2	x1	x4	-	x1	
M9000891 > 5600 mm	x1	x2	x1	x5	-	x1	
M9001170		x1 M9000730	x1	x4		x1	
Retailed kits	M9000886	M9000433	M9001138	M9000887	M9000888 [Ⓢ] M9000947 [Ⓢ] M9000462 [Ⓢ]	M9001132	

Ⓢ T13 & T15 & P14 Ⓢ T + PH T18->24; P17->P20; S17->S21 Ⓢ T26->T30 & P24

MAN TGA - TGS - TGX

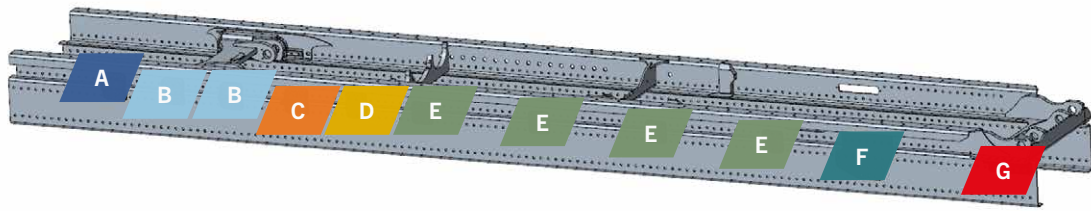

Diameter Durchmesser Diamètre (mm)	Length / Länge / Longueur (mm)					Nuts Nüsse Ecrus
	40	50	60	80	100	

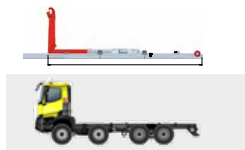

Ø14	M9000464 (qty 50/box)	M9000465 (qty 50/box)	-	M9001032 (qty 25/box)	M9001033 (qty 25/box)	M9000463 (qty 100/box)
-----	--------------------------	--------------------------	---	--------------------------	--------------------------	---------------------------

PH T 18-24 - HT 26-30

	A	B	C	D	E	F	G	Bolts / Schrauben / Visserie
				-				
M9000958 < 5600 mm + screws / Schrauben / Visserie	x1	x2	x1	-	x4	-	x1	
M9000976 ≥ 5600 mm + screws / Schrauben / Visserie	x1	x2	x1	-	x5	-	x1	
M9000894 ≤ 5600 mm	x1	x2	x1	-	x4	-	x1	
M9000895 > 5600 mm	x1	x2	x1	-	x5	-	x1	
M9001014	x1 M9000849	-	x1	-	x5	-	x1	
Retailed kits	M9000900	M9001156	M9001156	-	M9000902	M9000949 [Ⓞ]	M9001034	

TELESCOPIC T(A) 13-30 - POWER P(A) 14-24 - SYNCHRON S 14-21

	A	B	C	D	E	F	G	Bolts / Schrauben / Visserie
M9000959 < 5600 mm + screws / Schrauben / Visserie	x1	x1	x1	x1	x3	-	x1	
M9000977 ≥ 5600 mm + screws / Schrauben / Visserie	x1	x1	x1	x1	x4	-	x1	
M9000896 ≤ 5600 mm	x1	x1	x1	x1	x3	-	x1	
M9000897 > 5600 mm	x1	x1	x1	x1	x4	-	x1	
M9001171	x1 M9000779	-	x1	x1	x4	-	x1	
Retailed kits	M9000900	M9000451	M9000450	M9001139	M9000901	M9000904 [Ⓞ] M9000949 [Ⓞ] M9000949 [Ⓞ]	M9001134	

Ⓞ T13 & T15 & P14 Ⓞ T + PH T18->24; P17->P20; S17->S21 Ⓞ T26->T30 & P24

HEAVY RANGE MOUNTING KIT 13-30 T

SCHWERE REIHE MONTAGE BAUSATZ 13-30 T

GAMME LOURDE KIT DE FIXATION 13-30 T

MERCEDES ACTROS NEW, ANTOS & AROCS - LEAF SUSPENSION / *Stahlfederung / Suspension mécanique*

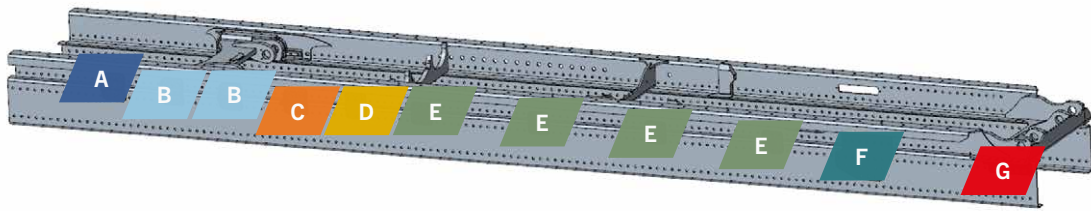

Diameter Durchmesser Diamètre (mm)	Length / Länge / Longueur (mm)					Nuts Nüsse Ecrus
	40	50	60	80	100	

	Ø14	M9000464 (qty 50/box)	M9000465 (qty 50/box)	-	M9001032 (qty 25/box)	M9001033 (qty 25/box)	M9000463 (qty 100/box)
	Ø16	-	M9000505 (qty 50/box)	M9000506 (qty 50/box)	M9001128 (qty 25/box)	M9001129 (qty 25/box)	M9000507 (qty 100/box)

PHT18-24 - HT 26-30

	A	B	C	D	E	F	G	Bolts / Schrauben / Visserie
				-				
M9000961 < 5600 mm + screws / Schrauben / Visserie	x1	x2	x1	-	x4	-	x1	
M9000979 ≥ 5600 mm + screws / Schrauben / Visserie	x1	x2	x1	-	x5	-	x1	
M9000905 ≤ 5600 mm	x1	x2	x1	-	x4	-	x1	
M9000906 > 5600 mm	x1	x2	x1	-	x5	-	x1	
M9001017	x1 M9000729		x1	-	x5	-	x1	
Retailed kits	M9000909	M9001160	M9001161	-	M9000910	M9000950 [Ⓞ]	M9000991	

TELESCOPIC T(A) 13-30 - POWER P(A) 14-24 - SYNCHRON S 14-21

	A	B	C	D	E	F	G	Bolts / Schrauben / Visserie
M9000962 < 5600 mm + screws / Schrauben / Visserie	x1	x1	x1	x1	x3	-	x1	
M9000980 ≥ 5600 mm + screws / Schrauben / Visserie	x1	x1	x1	x1	x4	-	x1	
M9000907 ≤ 5600 mm	x1	x1	x1	x1	x3	-	x1	
M9000908 > 5600 mm	x1	x1	x1	x1	x4	-	x1	
M9001172	x1 M9000729		x1	x1	x4	-	x1	
Retailed kits	M9000909	M9000647	M9000648	M9001140	M9001130	M9000913 [Ⓞ] M9000950 [Ⓞ] M9000950 [Ⓞ]	M9001133	

MERCEDES ACTROS NEW, ANTOS & AROCS - AIR SUSPENSION / Luftfederung / Suspension pneumatique

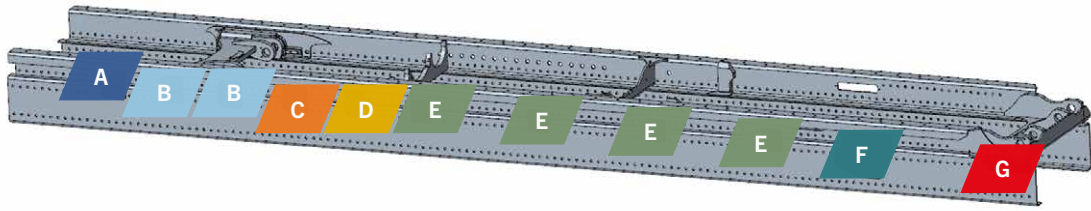

Diameter Durchmesser Diamètre Diamètre (mm)	Length / Länge / Longueur (mm)					Nuts Nüsse Ecrus
	40	50	60	80	100	
Ø14	M9000464 (qty 50/box)	M9000465 (qty 50/box)	-	-	-	M9000463 (qty 100/box)
Ø16	-	M9000505 (qty 50/box)	M9000506 (qty 50/box)	-	-	M9000507 (qty 100/box)



PH T 18-24 - HT 26-30

	A	B	C	D	E	F	G	Bolts / Schrauben / Visserie
				-		-		
M9000963 < 5600 mm + screws / Schrauben / Visserie	x1	x2	x1	-	x4	-	x1	
M9000981 ≥ 5600 mm + screws / Schrauben / Visserie	x1	x2	x1	-	x5	-	x1	
M9000914 ≤ 5600 mm	x1	x2	x1	-	x4	-	x1	
M9000915 > 5600 mm	x1	x2	x1	-	x5	-	x1	
M9001019	x1 M9000728		x1	-	x5	-	x1	
Retailed kits	M9000909	M9001160	M9001161	-	M9000920	-	M9000991	

TELESCOPIC T(A) 13-30 - POWER P(A) 14-24 - SYNCHRON S 14-21

	A	B	C	D	E	F	G	Bolts / Schrauben / Visserie
						-		
M9000964 < 5600 mm + screws / Schrauben / Visserie	x1	x2	x1	x1	x3	-	x1	
M9000982 ≥ 5600 mm + screws / Schrauben / Visserie	x1	x2	x1	x1	x4	-	x1	
M9000916 ≤ 5600 mm	x1	x2	x1	x1	x3	-	x1	
M9000917 > 5600 mm	x1	x2	x1	x1	x4	-	x1	
M9001173	x1 M9000728		-	x1	x4	-	x1	
Retailed kits	M9000909	M9000647	M9000648	M9001141	M9000920	-	M9001132	

HEAVY RANGE MOUNTING KIT 13-30 T

SCHWERE REIHE MONTAGE BAUSATZ 13-30 T

GAMME LOURDE KIT DE FIXATION 13-30 T

IVECO S WAY - X WAY

IVECO

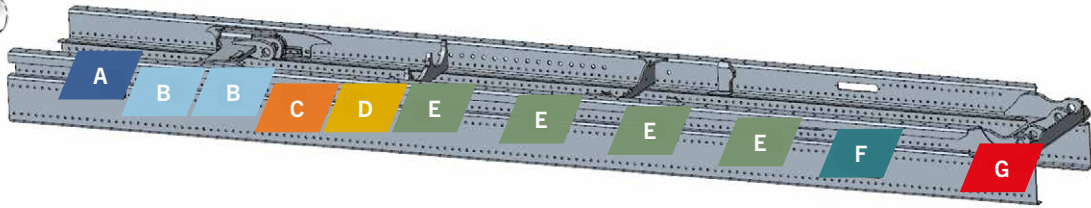

Diameter Durchmesser Diamètre (mm)	Length / Länge / Longueur (mm)					Nuts Nüsse Ecrus
	40	50	60	80	100	

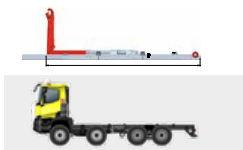

Ø14	M9000464 (qty 50/box)	M9000465 (qty 50/box)	-	M9001032 (qty 25/box)	M9001033 (qty 25/box)	M9000463 (qty 100/box)
-----	--------------------------	--------------------------	---	--------------------------	--------------------------	---------------------------

PH T 18-24 - HT 26-30

	A	B	C	D	E	F	G	Bolts / Schrauben / Visserie
				-				
M9000969 < 5600 mm + screws / Schrauben / Visserie	x1	x2	x1	-	x4	-	x1	
M9000987 ≥ 5600 mm + screws / Schrauben / Visserie	x1	x2	x1	-	x5	-	x1	
M9000931 ≤ 5600 mm	x1	x2	x1	-	x4	-	x1	
M9000932 > 5600 mm	x1	x2	x1	-	x5	-	x1	
M9001025	x1 M9000729	x1	x1	-	x4	-	x1	
Retailed kits	M9000935	M9001167	M9000740	-	M9000746	M9000952 [Ⓢ]	M9000994	

TELESCOPIC T(A) 13-30 - POWER P(A) 14-24 - SYNCHRON S 14-21

	A	B	C	D	E	F	G	Bolts / Schrauben / Visserie
M9000970 < 5600 mm + screws / Schrauben / Visserie	x1	x2	x1	x1	x3	-	x1	
M9000988 ≥ 5600 mm + screws / Schrauben / Visserie	x1	x2	x1	x1	x4	-	x1	
M9000933 ≤ 5600 mm	x1	x2	x1	x1	x3	-	x1	
M9000934 > 5600 mm	x1	x2	x1	x1	x4	-	x1	
M9001175	x1 M9000729	x1	x1	x1	x3	-	x1	
Retailed kits	M9000935	M9000739	M9000740	M9001142	M9001131	M9000938 [Ⓢ] M9000952 [Ⓢ] M9000951 [Ⓢ]	M9001338	

SCANIA P - R - G

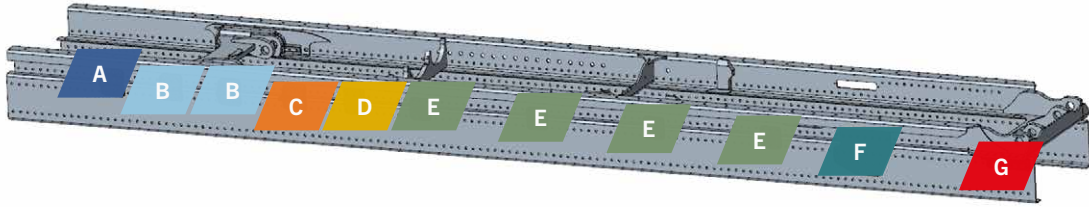

Diameter Durchmesser Diamètre (mm)	Length / Länge / Longueur (mm)					Nuts Nüsse Ecrus
	40	50	60	80	100	



Ø14	M9000464 (qty 50/box)	M9000465 (qty 50/box)	-	M9001032 (qty 25/box)	M9001033 (qty 25/box)	M9000463 (qty 100/box)
-----	--------------------------	--------------------------	---	--------------------------	--------------------------	---------------------------

PH T 18-24 - HT 26-30

	A	B	C	D	E	F	G	Bolts / Schrauben / Visserie
				-				
M9000966 < 5600 mm + screws / Schrauben / Visserie	x1	x2	x1	-	x4	-	x1	
M9000984 ≥ 5600 mm + screws / Schrauben / Visserie	x1	x2	x1	-	x5	-	x1	
M9000921 ≤ 5600 mm	x1	x2	x1	-	x4	-	x1	
M9000922 > 5600 mm	x1	x2	x1	-	x5	-	x1	
M9001022	x1 M9000729	x1	x1	-	x4	-	x1	
Retailed kits	M9000810 + M9000748	M9001165	M9001166	-	M9000927	M9000951 [Ⓞ]	M9000991	

TELESCOPIC T(A) 13-30 - POWER P(A) 14-24 - SYNCHRON S 14-21

	A	B	C	D	E	F	G	Bolts / Schrauben / Visserie
				-				
M9000967 < 5600 mm + screws / Schrauben / Visserie	x1	x1	x1	-	x4	-	x1	
M9000985 ≥ 5600 mm + screws / Schrauben / Visserie	x1	x1	x1	-	x5	-	x1	
M9000923 ≤ 5600 mm	x1	x1	x1	-	x4	-	x1	
M9000924 > 5600 mm	x1	x1	x1	-	x5	-	x1	
M9001174	x1 M9000729	x1	x1	-	x4	-	x1	
Retailed kits	M9000810 + M9000748	M9000853	M9000750	-	M9000928	M9000930 [Ⓞ] M9000951 [Ⓞ] M9000951 [Ⓞ]	M9001133	

HEAVY RANGE MOUNTING KIT 13-30 T



SCHWERE REIHE MONTAGE BAUSATZ 13-30 T

GAMME LOURDE KIT DE FIXATION 13-30 T



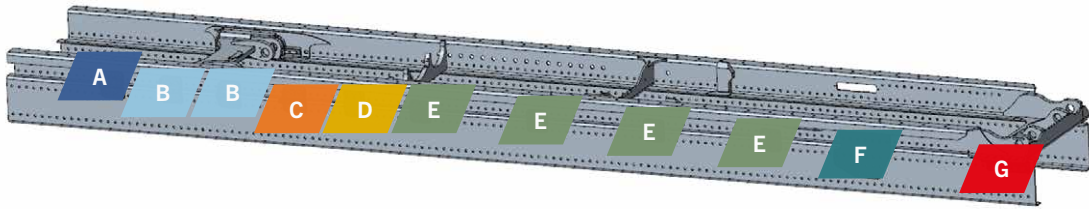









DAF XD-XF-XG

DAF

















	Diameter Durchmesser Diamètre (mm)	Length / Länge / Longueur (mm)					Nuts Nüsse Ecrus
		40	50	60	80	100	
	Ø14	M9000464 (qty 50/box)	M9000465 (qty 50/box)	-	M9001032 (qty 25/box)	M9001033 (qty 25/box)	M9000463 (qty 100/box)
	Ø16	-	M9000505 (qty 50/box)	M9000506 (qty 50/box)	M9001128 (qty 25/box)	M9001129 (qty 25/box)	M9000507 (qty 100/box)

PH T 18-24 - HT 26-30

	A	B	C	D	E	F	G	Bolts / Schrauben / Visserie
			-	-				
M9000971 < 5600 mm + screws / Schrauben / Visserie	x1	x2	-	-	x5	-	x1	
M9000989 ≥ 5600 mm + screws / Schrauben / Visserie	x1	x2	-	-	x6	-	x1	
M9000939 ≤ 5600 mm	x1	x2	-	-	x5	-	x1	
M9000940 > 5600 mm	x1	x2	-	-	x6	-	x1	
M9001027 	x1 M9000729	x1	-	-	x5	-	x1	
Retailed kits	M9000943	M9001169	-	-	M9000944	M9001010 [Ⓞ]	M9001007	

TELESCOPIC T(A) 13-30 - POWER P(A) 14-24 - SYNCHRON S 14-21

	A	B	C	D	E	F	G	Bolts / Schrauben / Visserie
			-					
M9000972 < 5600 mm + screws / Schrauben / Visserie	x1	x1	-	x1	x4	-	x1	
M9000990 ≥ 5600 mm + screws / Schrauben / Visserie	x1	x1	-	x1	x5	-	x1	
M9000941 ≤ 5600 mm	x1	x1	-	x1	x4	-	x1	
M9000942 > 5600 mm	x1	x1	-	x1	x5	-	x1	
M9001176 	x1 M9000729	x1	-	x1	x4	-	x1	
Retailed kits	M9000943	M9000337	-	M9001143	M9001122	M9001009 [Ⓞ] M9001010 [Ⓞ] M9001010 [Ⓞ]	M9001135	

Ⓞ T13 & T15 & P14 Ⓞ T + PH T18->24; P17->P20; S17->S21 Ⓞ T26->T30 & P24

ISUZU

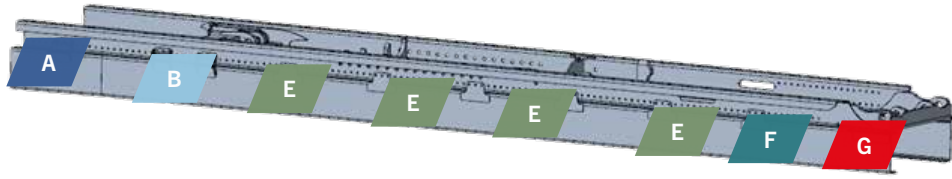

	Diameter Durchmesser Diamètre (mm)	Length / Länge / Longueur (mm)					Nuts Nüsse Ecrous
		40	50	60	80	100	
	Ø14	M9000464 (qty 50/box)	M9000465 (qty 50/box)	-	M9001032 (qty 25/box)	M9001033 (qty 25/box)	M9000463 (qty 100/box)
	Ø16	-	M9000505 (qty 50/box)	M9000506 (qty 50/box)	M9001128 (qty 25/box)	M9001129 (qty 25/box)	M9000507 (qty 100/box)

PH T 18-24 - HT 26-30

	A	B	C	D	E	F	G	Bolts / Schrauben / Visserie
			-	-				
M9001145	> 5600 mm	x1	x2	-	-	x6	-	x1
M9001179	> 5600 mm + screws / Schrauben / Visserie	x1	x2	-	-	x6	-	x1
Retailed kits	M9001155 +M9000810	M9001155	-	-	M9000920	M9001010	M9000991	

General accessories
Allgemeines Zubehör
Accessoires généraux

Hookloader
Abrollkipper
Polybenne

Skiploader
Absetzkipper
Multibenne

Retrofit kits
Nachrüstungssätze
Kits rétrofit

HEAVY RANGE MOUNTING KIT 13-30 T

SCHWERE REIHE MONTAGE BAUSATZ 13-30 T

GAMME LOURDE KIT DE FIXATION 13-30 T

ADDITIONAL RETAILED PARTS / Zus. Einzelteile / Pièces détaillées additionnelles

SPACERS / Abstandsplatten / Entretoises

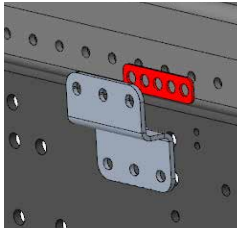

Part Nr/ Teil Nummer/ Référence	Holes diameter / Löcher Durchmesser / Diamètre perçage (mm)	Thickness / Dicke / Épaisseur (mm)	Holes step/ Löcher Schritt/ Pas de perçage (mm)
NEW! M5341549_80030	16.5	2	25
M5337510	16.5	3	25
M5337511	15	3	40

BOLTS FOR FLEXIBLE BRACKETS / Schrauben für Schubweich Befestigung / Visserie fixation souple

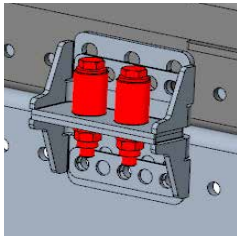

Part Nr/ Teil Nummer/ Référence	Screws diameter / Schrauben Durch- messer / Diamètre vis (mm)	Quality / Qualität / Qualité	Quantity per box / Menge pro Box / Quantité par boîte
M9000810	M14	10.9	2

PH T SCAN MOUNTING KIT

PH T SCAN MONTAGE BAUSATZ
PH T SCAN KIT FIXATION



General accessories
Allgemeines Zubehör
Accessoires généraux

Hookloader
Abrollkipper
Polybenne

Skiploader
Absetzkipper
Multibenne

Retrofit kits
Nachrüstungssätze
Kits rétrofit

PH T SCAN MOUNTING KIT

PH T SCAN MONTAGE BAUSATZ

PH T SCAN KIT FIXATION

SCANIA P - R - G

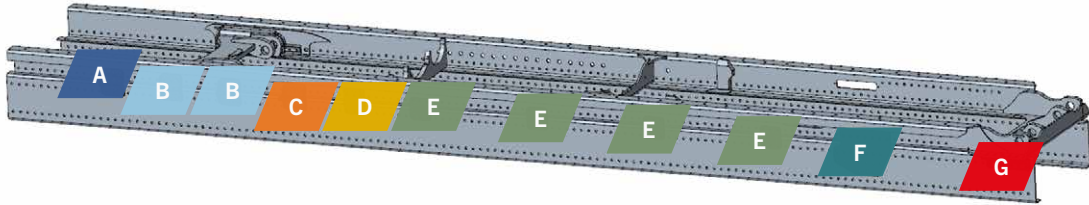

Diameter Durchmesser Diamètre (mm)	40	50	60	80	100	Nuts Nüsse Ecrous
---	----	----	----	----	-----	-------------------------



Ø14	M9000464 (qty 50/box)	M9000465 (qty 50/box)	-	M9001032 (qty 25/box)	M9001033 (qty 25/box)	M9000463 (qty 100/box)
-----	--------------------------	--------------------------	---	--------------------------	--------------------------	---------------------------

PH T(A) 17-24 SCAN

		A	B	C	D	E	F	G	Bolts / Schrauben / Visserie
					-		-		
M9000968	< 5600 mm + screws / Schrauben / Visserie	x1	x2	x1	-	x5	-	x1	
M9000986	≥ 5600 mm + screws / Schrauben / Visserie	x1	x2	x1	-	x6	-	x1	
M9000925	≤ 5600 mm	x1	x2	x1	-	x5	-	x1	
M9000926	> 5600 mm	x1	x2	x1	-	x6	-	x1	
M9001024		x1 M9000729	x1	x1	-	x3	-	x1	
Retailed kits	M9000810 + M9000748	M9001165	M9001166	-	M9000928	-	M9000993		

RENAULT T-K -C - VOLVO FMX-FH-FM

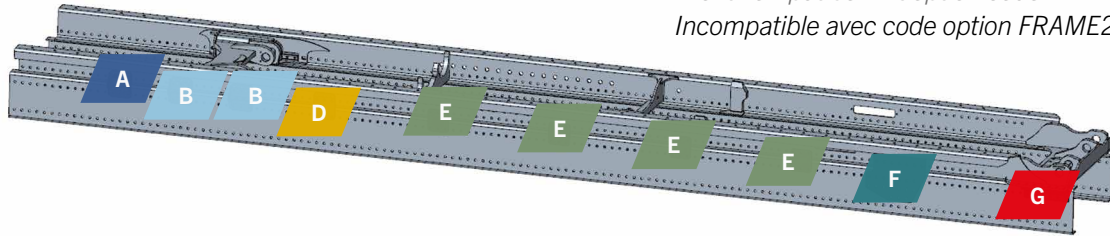

Incompatible with option code FRAME266

Nicht kompatibel mit option code FRAME266.

Incompatible avec code option FRAME266.

Diameter Durchmesser Diamètre (mm)	Length / Länge / Longueur (mm)					Nuts Nüsse Ecrus
	40	50	60	80	100	
Ø14	M9000464 (qty 50/box)	M9000465 (qty 50/box)	-	M9001032 (qty 25/box)	M9001033 (qty 25/box)	M9000463 (qty 100/box)

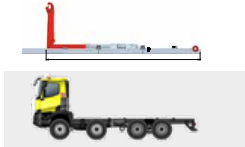

PH T(A) 17-24 SCAN

	A	B	D	E	F	G	Bolts / Schrauben / Visserie
			-		-		
M9000957 < 5600 mm + screws / Schrauben / Visserie	x1	x2	-	x5	-	x1	
M9000975 ≥ 5600 mm + screws / Schrauben / Visserie	x1	x2	-	x6	-	x1	
M9000892 ≤ 5600 mm	x1	x2	-	x5	-	x1	
M9000893 > 5600 mm	x1	x2	-	x6	-	x1	
M9001013		x1 M9000730		x6		x1	
Retailed kits	M9000886	M9001155	-	M9000887	-	M9000993	

PH T SCAN MOUNTING KIT

PH T SCAN MONTAGE BAUSATZ

PH T SCAN KIT FIXATION

MAN TGA - TGS - TGX

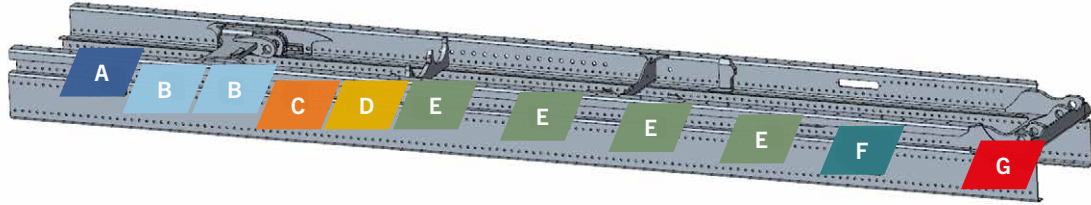

Diameter Durchmesser Diamètre (mm)	Length / Länge / Longueur (mm)					Nuts Nüsse Ecrous
	40	50	60	80	100	
Ø14	M9000464 (qty 50/box)	M9000465 (qty 50/box)	-	M9001032 (qty 25/box)	M9001033 (qty 25/box)	M9000463 (qty 100/box)

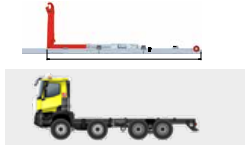

PH T(A) 17-24 SCAN

	A	B	C	D	E	F	G	Bolts / Schrauben / Visserie
				-		-		
M9000960 < 5600 mm + screws / Schrauben / Visserie	x1	x2	x1	-	x4	-	x1	
M9000978 ≥ 5600 mm + screws / Schrauben / Visserie	x1	x2	x1	-	x5	-	x1	
M9000898 ≤ 5600 mm	x1	x2	x1	-	x4	-	x1	
M9000899 > 5600 mm	x1	x2	x1	-	x5	-	x1	
M9001016	x1 M9000781		x1	-	x5	-	x1	
Retailed kits	M9000900	M9001156	M9001156	-	M9000901	-	M9001035	

MERCEDES ACTROS NEW, ANTOS & AROCS - AIR SUSPENSION / Luftfederung / Suspension pneumatique

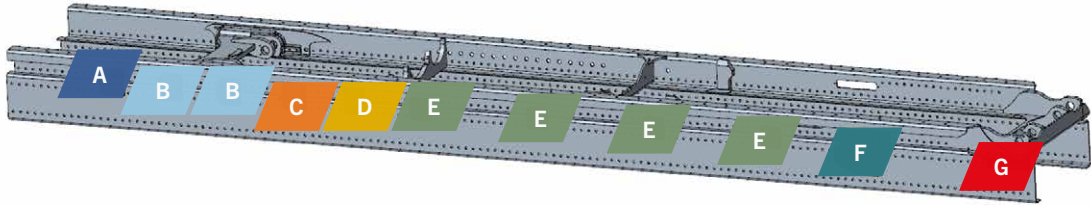

Diameter Durchmesser Diamètre (mm)	Length / Länge / Longueur (mm)					Nuts Nüsse Ecrous
	40	50	60	80	100	
Ø14	M9000464 (qty 50/box)	M9000465 (qty 50/box)	-	M9001032 (qty 25/box)	M9001033 (qty 25/box)	M9000463 (qty 100/box)
Ø16	-	M9000505 (qty 50/box)	M9000506 (qty 50/box)	M9001128 (qty 25/box)	M9001129 (qty 25/box)	M9000507 (qty 100/box)



PH T(A) 17-24 SCAN

	A	B	C	D	E	F	G	Bolts / Schrauben / Visserie
				-		-		
M9000965 < 5600 mm + screws / Schrauben / Visserie	x1	x2	x1	-	x4	-	x1	
M9000983 ≥ 5600 mm + screws / Schrauben / Visserie	x1	x2	x1	-	x5	-	x1	
M9000918 ≤ 5600 mm	x1	x2	x1	-	x4	-	x1	
M9000919 > 5600 mm	x1	x2	x1	-	x5	-	x1	
M9001021	x1 M9000728		x1	-	x5	-	x1	
Retailed kits	M9000909	M9001160	M9001161	-	M9000920	-	M9000993	

General accessories
Allgemeines Zubehör
Accessoires généraux

Hookloader
Abrollkipper
Polybenne

Skiploader
Absetzkipper
Multibenne

Retrofit kits
Nachrüstungssätze
Kits rétrofit

PH T SCAN MOUNTING KIT

PH T SCAN MONTAGE BAUSATZ

PH T SCAN KIT FIXATION

XD - XG

DAF

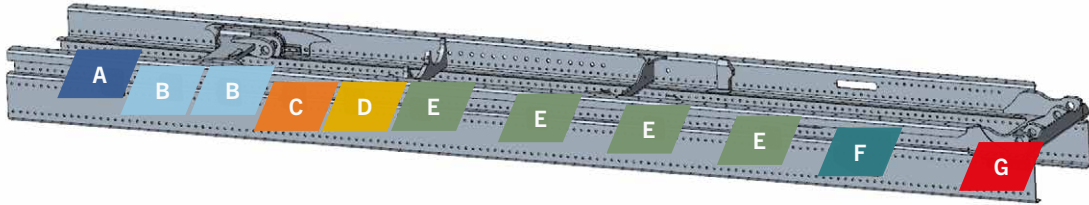

	Diameter Durchmesser Diamètre (mm)	Length / Länge / Longueur (mm)					Nuts Nüsse Ecrous
		40	50	60	80	100	
	Ø14	M9000464 (qty 50/box)	M9000465 (qty 50/box)	-	M9001032 (qty 25/box)	M9001033 (qty 25/box)	M9000463 qty (100/box)
	Ø16	-	M9000505 (qty 50/box)	M9000506 (qty 50/box)	M9001128 (qty 25/box)	M9001129 (qty 25/box)	M9000507 (qty 100/box)

PH T(A) 17-24 SCAN

		A	B	C	D	E	F	G	Boils / Schrauben / Visserie
				-	-		-		
M9001120	< 5600 mm + screws / Schrauben / Visserie	x1	x2	-	-	x4	-	x1	
M9001121	≥ 5600 mm + screws / Schrauben / Visserie	x1	x2	-	-	x5	-	x1	
M9001118	≤ 5600 mm	x1	x2	-	-	x4	-	x1	
M9001119	> 5600 mm	x1	x2	-	-	x5	-	x1	
M9001123		x1 M9000729	x1	-	-	x5	-	x1	
Retailed kits		M9000943	M9001169	-	-	M9001122	-	M9000993	

MIDDLE RANGE MOUNTING KIT 5-8 T

MITTEL REIHE

MONTAGE BAUSATZ 5-8 T

GAMME MOYENNE

KIT DE FIXATION 5-8 T



General accessories
Allgemeines Zubehör
Accessoires généraux

Hookloader
Abrollkipper
Polybenne

Skiploader
Absetzkipper
Multibenne

Retrofit kits
Nachrüstungssätze
Kits retrofit

PH T 05 MOUNTING KIT







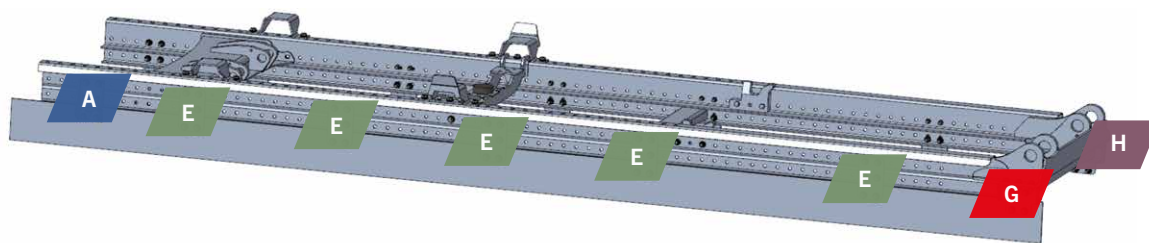



PH T 05 MONTAGEBAUSATZ

PH T 05 KIT FIXATION

MAN TGL



PH T 05

	A	B	D	E	F	G	H	Bolts / Schrauben / Visserie
		-	-		-			
M9001080 < 3300 mm + screws / Schrauben / Visserie	x1	-	-	x4	-	x1	x1	
M9001081 ≥3300 mm + screws / Schrauben / Visserie	x1	-	-	x5	-	x1	x1	
M9001082 < 3300 mm	x1	-	-	x4	-	x1	x1	
M9001083 ≥ 3300 mm	x1	-	-	x5	-	x1	x1	
Retailed kits	M9001104	-	-	M9001105	-	M9000812	M9000811	

NEW!

Reference / Teil Nummer / Référence	Designation / Bezeichnung / Désignation	Dimensions / Mase / Dimensions	Qty
M2375322	Pump 40cc	Gearbox ratio 0,5	1
M2372022	Pump 18cc	Gearbox ratio 1,4	1
M2372020	Tank kit 30L	30L Wheel base mounted	1
M9000825	30L tank support	For 30L tank	1
M2371057	Tank kit 50L	50L Wheel base mounted	1
M9001362	Kit twin tire plastic mudguard	530 x 1020	1
M9000705	Anti-spray mudflaps kit	400x700	1
M9000400	Side protection kit	3,5M alu profil (x4)	1
M9000481	Rear lights support kit		1
M9001207	Alu corner for reflective tape	2x1500mm	1
M5332091_80061	Working light support		1
M65031193	Working light 12-24VDC		1
M5329924_80036	MAN side light support		4

RECOMMENDED ACCESSORIES

MERCEDES ATEGO

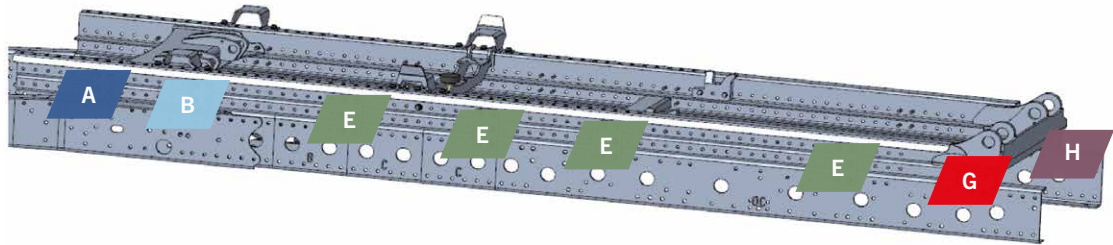

PH T 05

		A	B	D	E	F	G	H	Bolts / Schrauben / Visserie
M9001084	< 3300 mm + screws / Schrauben / Visserie	x1	x1	-	x4	-	x1	x1	
M9001085	≥ 3300 mm + screws / Schrauben / Visserie	x1	x1	-	x5	-	x1	x1	
M9001086	< 3300 mm	x1	x1	-	x4	-	x1	x1	
M9001087	≥ 3300 mm	x1	x1	-	x5	-	x1	x1	
Retailed kits		M9001106	M9001116	-	M9000817	-	M9000815	M9000811	

NEW!

Reference / Teil Nummer / Référence	Designation / Bezeichnung / Désignation	Dimensions / Mase / Dimensions	Qty
M2375300	Pump 25cc	Gearbox ratio 1	1
M2375331	Pump 32cc	Gearbox ratio 0,8	1
M2372020	Tank kit 30L	30L Wheel base mounted	1
M9000825	30L tank support	For 30L tank	1
M2371057	Tank kit 50L	50L Wheel base mounted	1
M9001362	Kit twin tire plastic mudguard	530 x 1020	1
M9000705	Anti-spray mudflaps kit	400x700	1
M9000400	Side protection kit	3,5M alu profil (x4)	1
M9000481	Rear lights support kit		1
M9001207	Alu corner for reflective tape	2x1500mm	1
M5332091_80061	Working light support		1
M65031193	Working light 12-24VDC		1
M5317314_80036	MERCEDES side light support		4

RECOMMENDED ACCESSORIES

General accessories
Allgemeines Zubehör
Accessoires généraux

Hookloader
Abrollkipper
Polybenne

Skiploader
Absetzkipper
Multibenne

Retrofit kits
Nachrüstungssätze
Kits rétrofit

PH T 05 MOUNTING KIT

PH T 05 MONTAGEBAUSATZ

PH T 05 KIT FIXATION

RENAULT D75 - IVECO DAILY 65-70 C



IVECO

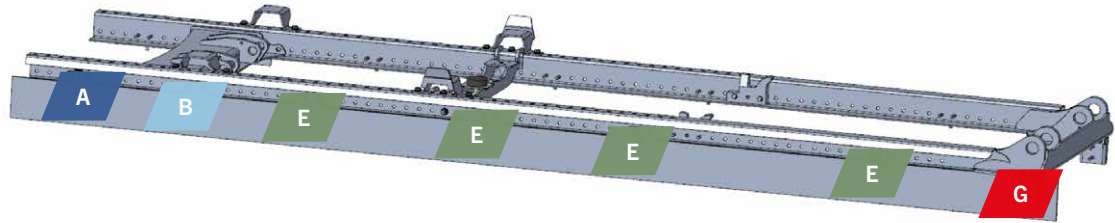

PH T 05

		A	B	D	E	F	G	H	Bolts / Schrauben / Visserie
M9001088	< 3300 mm + screws / Schrauben / Visserie	x1	x1	-	x4	-	x1	-	
M9001089	≥ 3300 mm + screws / Schrauben / Visserie	x1	x1	-	x5	-	x1	-	
M9001090	< 3300 mm	x1	x1	-	x4	-	x1	-	
M9001091	≥ 3300 mm	x1	x1	-	x5	-	x1	-	
Retailed kits		M9001107	M9001108	-	M9001109	-	M9000807	-	

NEW!

Reference / Teil Nummer / Référence	Designation / Bezeichnung / Désignation	Dimensions / Mase / Dimensions	Qty
M2375300	Pump 25cc	Gearbox ratio 0,9-1,15	1
M2372020	Tank kit 30L	30L Wheel base mounted	1
M9000825	30L tank support	For 30L tank	1
M2371057	Tank kit 50L	50L Wheel base mounted	1
M9001361	Kit twin tire plastic mudguard	530 x 860	1
M9000705	Anti-spray mudflaps kit	400x700	1
M9000400	Side protection kit	3,5M alu profil (x4)	1
M9000481	Rear lights support kit		1
M9001207	Alu corner for reflective tape	2x1500mm	1
M5332091_80061	Working light support		1
M65031193	Working light 12-24VDC		1
M5317314_80036	RENAULT TRUCKS side light support		4
No part for IVECO			







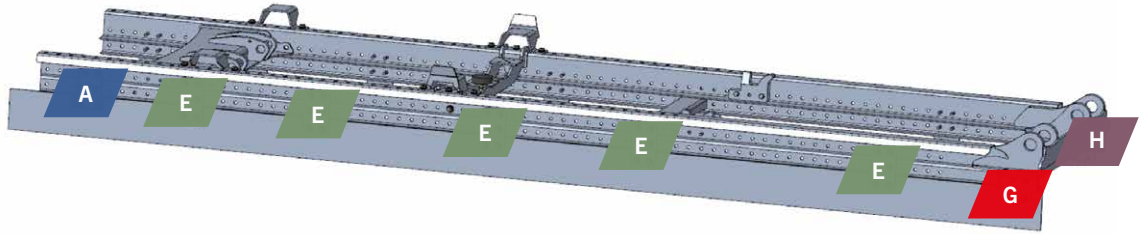





RECOMMENDED ACCESSORIES

DAF LF

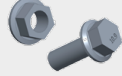
DAF



PH T 05

		A	B	D	E	F	G	H	Bolts / Schrauben / Visserie
									
M9001092	< 3300 mm + screws / Schrauben / Visserie	x1	-	-	x4	-	x1	-	
M9001093	≥ 3300 mm + screws / Schrauben / Visserie	x1	-	-	x5	-	x1	-	
M9001094	< 3300 mm	x1	-	-	x4	-	x1	-	
M9001095	≥ 3300 mm	x1	-	-	x5	-	x1	-	
Retailed kits	M9001110	-	-	M9000822	-	M9000820	M9000811		

NEW!

Reference / Teil Nummer / Référence	Designation / Bezeichnung / Désignation	Dimensions / Mase / Dimensions	Qty
M2375300	Pump 25cc	Gearbox ratio 0,9-1,15	1
M2375332	Pump 41cc	Gearbox ratio 0,5-0,7	1
M2372020	Tank kit 30L	30L Wheel base mounted	1
M9000825	30L tank support	For 30L tank	1
M2371057	Tank kit 50L	50L Wheel base mounted	1
M9001362	Kit twin tire plastic mudguard	530 x 1020	1
M9000705	Anti-spray mudflaps kit	400x700	1
M9000400	Side protection kit	3,5M alu profil (x4)	1
M9000481	Rear lights support kit		1
M9001207	Alu corner for reflective tape	2x1500mm	1
M5332091_80061	Working light support		1
M65031193	Working light 12-24VDC		1
M5329925_80036	DAF side light support		4

RECOMMENDED ACCESSORIES

General accessories
Allgemeines Zubehör
Accessoires généraux

Hookloader
Abrollkipper
Polybenne

Skiploader
Absetzkipper
Multibenne

Retrofit kits
Nachrüstungssätze
Kits rétrofit

PH T 05 MOUNTING KIT

MONTAGEBAUSATZ FÜR PH T 05

PH T 05 KIT FIXATION

MAN TGE - VOLKSWAGEN CRAFTER - SINGLE TIRE / Einzelreifen / Monte simple



Volkswagen

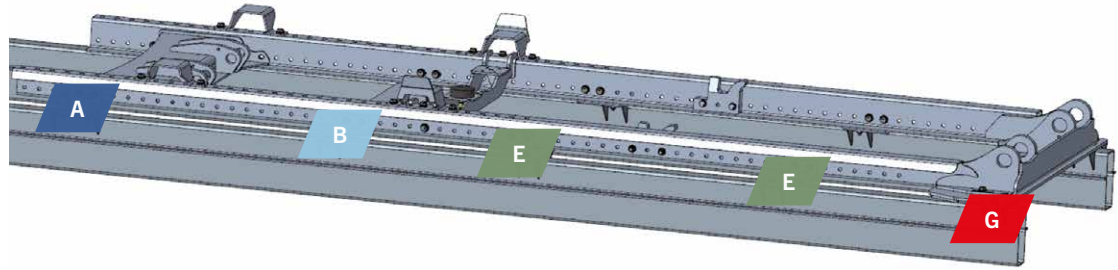

PH T 05

	A	B	D	E	F	G	H	Bolts / Schrauben / Visserie
M9001096			-		-		-	
	< 3300 mm + screws / Schrauben / Visserie	x1	x1	-	x2	-	x1	-
M9001097			-		-		-	
	≥ 3300 mm + screws / Schrauben / Visserie	x1	x2	-	x2	-	x1	-
Retailed kits	M9001111	M9000875	-	M9001112	-	M9001113	-	

NEW!

Reference / Teil Nummer / Référence	Designation / Bezeichnung / Désignation	Dimensions / Mase / Dimensions	Qty
M2375300	Pump 25cc	Gearbox ratio 0,9-1,15	1
M2372020	Tank kit 30L	30L Wheel base mounted	1
M9000825	30L tank support	For 30L tank	1
M2371057	Tank kit 50L	50L Wheel base mounted	1
M9000686	Kit twin tire plastic mudguard	270 x 815	1
M9000566	Fixation for 1 single mudguard	For tube diam. 34mm	2
M9000705	Anti-spray mudflaps kit	400x700	1
M9000400	Side protection kit	3,5M alu profil (x4)	1
M9000481	Rear lights support kit		1
M9001207	Alu corner for reflective tape	2x1500mm	1
M5332091_80061	Workinglight support		1
M65031193	Working light 12-24VDC		1

RECOMMENDED ACCESSORIES

MAN TGE - VOLKSWAGEN CRAFTER - TWIN TIRE / Doppelreifen / Monte jumelée



Volkswagen

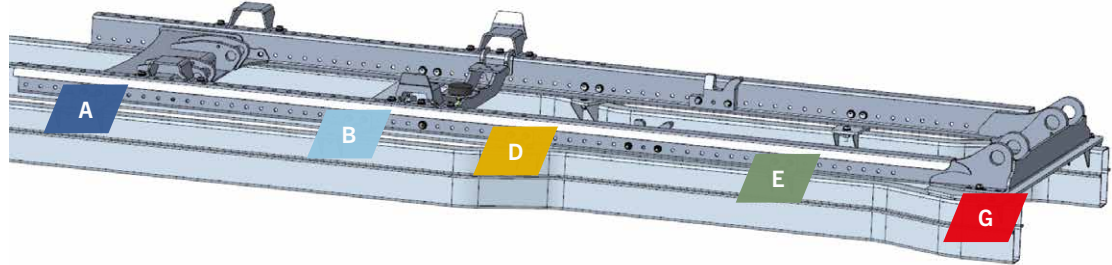

PH T 05

	A	B	D	E	F	G	H	Bolts / Schrauben / Visserie
M9001100	< 3300 mm + screws / Schrauben / Visserie	x1	x1	x1	x1	-	x1	-
M9001101	≥ 3300 mm + screws / Schrauben / Visserie	x1	x2	x1	x1	-	x1	-
Retailed kits	M9001111	M9000875	M9001114	M9001115	-	M9001113	-	

NEW!

Reference / Teil Nummer / Référence	Designation / Bezeichnung / Désignation	Dimensions / Mase / Dimensions	Qty
M2375300	Pump 25cc	Gearbox ratio 0,9-1,15	1
M2372020	Tank kit 30L	30L Wheel base mounted	1
M9000825	30L tank support	For 30L tank	1
M2371057	Tank kit 50L	50L Wheel base mounted	1
M9000563	Kit twin tire plastic mudguard	455 x 860	1
M9000566	Fixation for 1 single mudguard	For tube diam. 34mm	2
M9000705	Anti-spray mudflaps kit	400x700	1
M9000400	Side protection kit	3,5M alu profil (x4)	1
M9000481	Rear lights support kit		1
M9001207	Alu corner for reflective tape	2x1500mm	1
M5332091_80061	Workinglight support		1
M65031193	Working light 12-24VDC		2

RECOMMENDED ACCESSORIES

General accessories
Allgemeines Zubehör
Accessoires généraux

Hookloader
Abrollkipper
Polybenne

Skiploader
Absetzkipper
Multibenne

Retrofit kits
Nachrüstungssätze
Kits rétrofit

HT 07S-08 MOUNTING KIT

HT 07S-08 MONTAGEBAUSATZ

HT 07S-08 KIT FIXATION

NEW!

RENAULT TRUCKS D – VOLVO FL 12-10

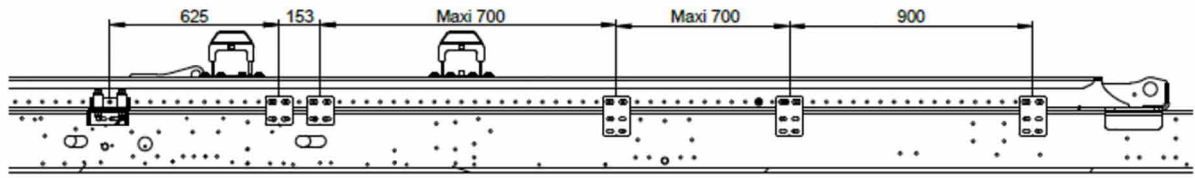

Reference	Designation	Required qty
M9000587	Screw M12x40 (qty 25/box)	3
M9000588	Nut M12 (qty 25/box)	3

HT 07S-08



Reference	Designation	A	B	D	E	F	G	H	Remarks
M9001236	L ≤ 3950	1	2	-	3	-	1	-	
M9001238	L > 3950	1	2	-	4	-	1	-	
M9001232	L ≤ 3950	1	2	-	3	-	1	-	
M9001237	L > 3950	1	2	-	4	-	1	-	
Retailed fixing kit (Left and right side)	M9001223 M9001222	-	-	-	M9001226	-	M9001219	-	

RECOMMENDED ACCESSORIES

Reference / Teil Nummer / Référence	Designation / Bezeichnung / Désignation	Remarks
M9002020	30L tank	Only SLD3 – Q < 30l/min
M9001225	30L tank support	
M9001238	50L tank	
M2375300	Pump XPI 25cc – 1"1/12 & 1"	SLD3
M2375331	Pump XPI 32cc – 1"1/12	SLD3
M2375332	Pump XPI 41cc – 1"1/12	SLD5/TEC5
M9000400	Side protection	
M9000405	Articulation kit for side protection	
M9000481	Rear lights support kit	
M9000497	Netbox	
M5341402_80036	Net box support (to be ordered by 2)	
M9001207	Alu corner for reflective tape	
M5332091_80061	Worklight support	
M65031193	LED Worklight 12-24 VDC	
M5317314_80036	Renault truck side light support	
M9001363	Mud guard kit	
M9001198	Back vision kit	SLD3/SLD5

NEW!

IVECO EUROCARGO

IVECO

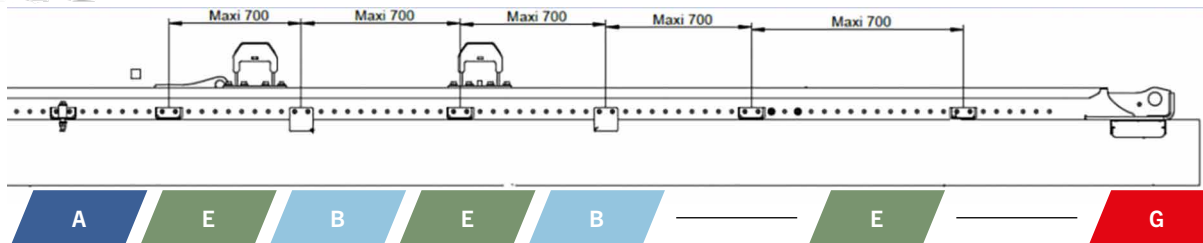

Reference	Designation	Required qty
M9000587	Screw M12x40 (qty 25/box)	2
M9000588	Nut M12 (qty 25/box)	2
M9000592	Screw M14x40 (qty 25/box)	1
M9000593	Nut M14 (qty 25/box)	1

HT 07S-08



Reference	Designation	A	B	D	E	F	G	H	Image
M9001240	L ≤ 3950	1	2	-	5	-	1	-	
M9001242	L > 3950	1	3	-	5	-	1	-	
M9001239	L > 3950	1	2	-	5	-	1	-	
M9001241	L > 3950	1	3	-	5	-	1	-	
Retailed fixing kit (Left and right side)		M9001244	M9001243	-	M9001245	-	M9001219	-	

RECOMMENDED ACCESSORIES

Reference / Teil Nummer / Référence	Designation / Bezeichnung / Désignation	Remarks
M2372020	30L tank	Only SLD3 – Q<30l/min
M9001225	30L tank support	
M9001238	50L tank	
M2375300	Pump XPI 25cc – 1"1/12 & 1"	SLD3
M2375331	Pump XPI 32cc – 1"1/12	SLD3
M2375332	Pump XPI 41cc – 1"1/12	SLD5/TEC5
M9000400	Side protection	
M9000405	Articulation kit for side protection	
M9000481	Rear lights support kit	
M9000497	Nebox	
M5341402_80036	Net box support (to be ordered by 2)	
M9001207	Alu corner for reflective tape	
M5332091_80061	Worklight support	
M65031193	LED Worklight 12-24 VDC	
M9001363	Mud guard kit	
M9001198	Back vision kit	SLD3/SLD5

General accessories
Allgemeines Zubehör
Accessoires généraux

Hookloader
Abrollkipper
Polybenne

Skiploader
Absetzkipper
Multibenne

Retrofit kits
Nachrüstungssätze
Kits rétrofit

HT 07S-08 MOUNTING KIT

HT 07S-08 MONTAGEBAUSATZ

HT 07S-08 KIT FIXATION

NEW!

MAN TGL 10-12

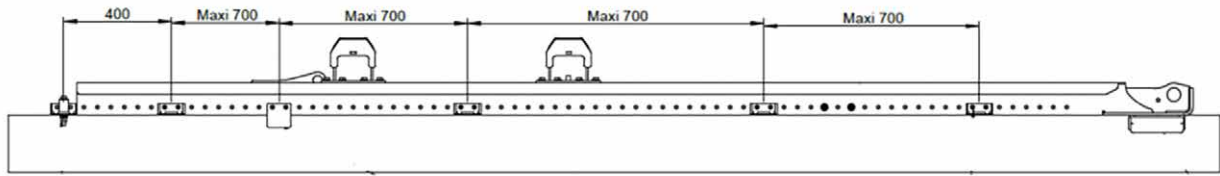

Reference	Designation	Required qty
M9000587	Screw M12x40 (qty 25/box)	3
M9000588	Nut M12 (qty 25/box)	3

HT 07S-08

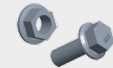

Reference	Designation	A	B	D	E	F	G	H	Remarks
M9001268	L ≤ 3950	1	1	-	4	-	1	-	
M9001270	L > 3950	1	2	-	4	-	1	-	
M9001267	L ≤ 3950	1	1	-	4	-	1	-	
M9001269	L > 3950	1	2	-	4	-	1	-	
Retailed fixing kit (Left and right side)		M9001107	M9001108	-	M9001109	-	M9001219	-	

RECOMMENDED ACCESSORIES

Reference / Teil Nummer / Référence	Designation / Bezeichnung / Désignation	Remarks
M9001236	30L tank	Only SLD3 – Q < 30l/min
M9001225	30L tank support	
M9001238	50L tank	
M2375300	Pump XPi 25cc – 1"1/12 & 1"	SLD3, PTO i=1,16
M2375331	Pump XPi 32cc – 1"1/12	SLD3, PTO i=1,16
M2375332	Pump XPi 41cc – 1"1/12	SLD5/TEC5, PTO i=1,16
M2375333	Pump XPi 63cc – 1"1/12	SLD3, PTO i=0,53
M2371310	Pump XPi 80cc – 2"	SLD5/TEC5, PTO i=0,53
M9000400	Side protection	
M9000405	Articulation kit for side protection	
M9000481	Rear lights support kit	
M9000497	Nebox	
M5341402_80036	Net box support (to be ordered by 2)	
M9001207	Alu corner for reflective tape	
M5332091_80061	Worklight support	
M65031193	LED Worklight 12-24 VDC	
M5329924_80036	MAN truck side light support	
M9001363	Mud guard kit	
M9001198	Back vision kit	SLD3/SLD5

NEW!

MERCEDES ATEGO 10-12

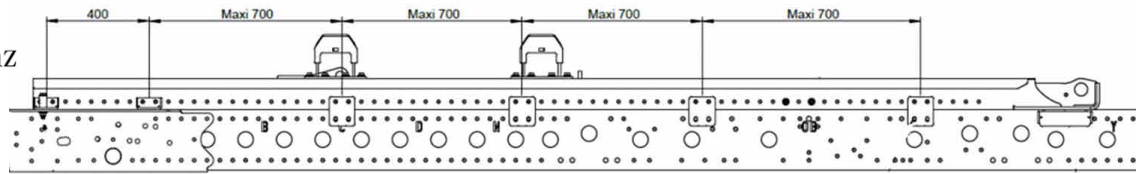

Reference	Designation	Required qty
M9000587	Screw M12x40 (qty 25/box)	3
M9000588	Nut M12 (qty 25/box)	3

HT 07S-08



M9001254	L<=3950	1	1	-	4	-	1	-	
M9001256	L>3950	1	1	-	5	-	1	-	
M9001253	L<=3950	1	1	-	4	-	1	-	
M9001255	L>3950	1	1	-	4	-	1	-	
Retailed fixing kit (Left and right side)		M9001252	M9001251	-	M9001250	-	M9001219	-	

RECOMMENDED ACCESSORIES

Reference / Teil Nummer / Référence	Designation / Bezeichnung / Désignation	Remarks
M9002020	30L tank	Only SLD3 – Q<30l/min
M9001225	30L tank support	
M9001238	50L tank	
M2375300	Pump XPI 25cc – 1"1/12 & 1"	SLD3, PTO i=1,04
M2375331	Pump XPI 32cc – 1"1/12	SLD3, PTO i=1,04
M2375332	Pump XPI 41cc – 1"1/12	SLD5/TEC5, PTO i=1,04
M2375332	Pump XPI 41cc – 1"1/12	SLD3, PTO i=0,79
M2375333	Pump XPI 63cc – 2"	SLD5/TEC5, PTO i=0,79
M9000400	Side protection	
M9000405	Articulation kit for side protection	
M9000481	Rear lights support kit	
M9000497	Nebox	
M5341402_80036	Net box support (to be ordered by 2)	
M9001207	Alu corner for reflective tape	
M5332091_80061	Worklight support	
M65031193	LED Worklight 12-24 VDC	
M5317314_80036	MB truck side light support	
M9001363	Mud guard kit	
M9001198	Back vision kit	SLD3/SLD5

General accessories
Allgemeines Zubehör
Accessoires généraux

Hookloader
Abrollkipper
Polybenne

Skiploader
Absetzkipper
Multibenne

Retrofit kits
Nachrüstungssätze
Kits rétrofit

HT 07S-08 MOUNTING KIT

HT 07S-08 MONTAGEBAUSATZ

HT 07S-08 KIT FIXATION

NEW!

ISUZU F11

ISUZU

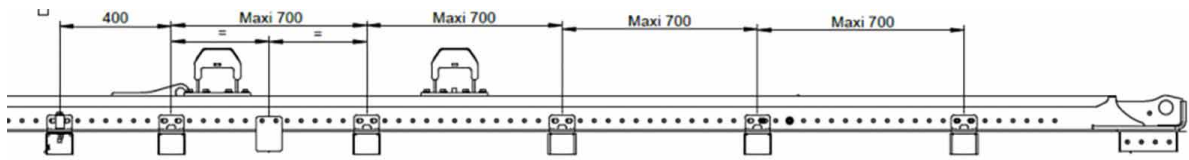

Reference	Designation	Required qty
M9000587	Screw M12x40 (qty 25/box)	3
M9000588	Nut M12 (qty 25/box)	3

HT 07S-08



Reference	Designation	A	B	D	E	F	G	H	Remarks
M9001274	L ≤ 3950	1	1	-	6	-	1	-	
M9001276	L > 3950	1	2	-	6	-	1	-	
M9001273	L ≤ 3950	1	1	-	6	-	1	-	
M9001275	L > 3950	1	2	-	6	-	1	-	
Retailed fixing kit (Left and right side)	M9001279 + M9001282 + M9000810	M9001280	-	M9001279 + M9001282	-	M9001283	-	-	

Reference / Teil Nummer / Référence	Designation / Bezeichnung / Désignation	Remarks
M9002020	30L tank	Only SLD3 – Q<30l/min
M9001225	30L tank support	
M9001238	50L tank	
M2375300	Pump XPi 25cc – 1"1/12 & 1"	SLD3, PTO i=1,04
M2375331	Pump XPi 32cc – 1"1/12	SLD3, PTO i=1,04
M2375332	Pump XPi 41cc – 1"1/12	SLD5/TEC5, PTO i=1,04
M2375332	Pump XPi 41cc – 1"1/12	SLD3, PTO i=0,79
M2375333	Pump XPi 63cc – 2"	SLD5/TEC5, PTO i=0,79
M9000400	Side protection	
M9000405	Articulation kit for side protection	
M9000481	Rear lights support kit	
M9000497	Nebox	
M5341402_80036	Net box support (to be ordered by 2)	
M9001207	Alu corner for reflective tape	
M5332091_80061	Worklight support	
M65031193	LED Worklight 12-24 VDC	
M9001363	Mud guard kit	
M9001198	Back vision kit	SLD3/SLD5

RECOMMENDED ACCESSORIES

NEW!

DAF LF10

DAF

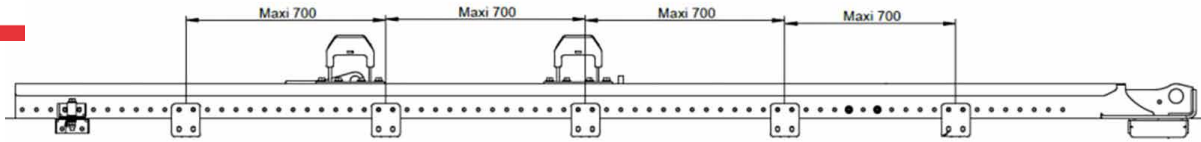

A

E

E

E

E

E

G

Reference	Designation	Required qty
M9000587	Screw M12x50 (qty 25/box)	3
M9000588	Nut M12 (qty 25/box)	3

HT 07S-08

A

B

D

E

F

G

H

Bolts / Schrauben / Visserie



M9001264	L<=3950	1	-	-	5	-	1	-	
M9001266	L>3950	1	-	-	6	-	1	-	
M9001263	L<=3950	1	-	-	5	-	1	-	
M9001265	L>3950	1	-	-	6	-	1	-	
Retailed fixing kit (Left and right side)		M9001260 + M9001261	-	-	M9001258	-	M9001219	-	

RECOMMENDED ACCESSORIES

Reference / Teil Nummer / Référence	Designation / Bezeichnung / Désignation	Remarks
M9002020	30L tank	Only SLD3 – Q<30l/min
M9001225	30L tank support	
M9001238	50L tank	
M2375300	Pump XPi 25cc – 1"1/12 & 1"	SLD3, PTO i=1,01
M2375331	Pump XPi 32cc – 1"1/12	SLD3, PTO i=1,01
M2375332	Pump XPi 41cc – 1"1/12	SLD5/TEC5, PTO i=1,01
M2375332	Pump XPi 41cc – 1"1/12	SLD3, PTO i=0,67
M2375333	Pump XPi 63cc – 2"	SLD5/TEC5, PTO i=0,67
M2375333	Pump XPi 63cc – 2"	SLD3, PTO i=0,53
M2371310	Pump XPi 80cc – 2"	SLD5/TEC5, PTO i=0,53
M9000400	Side protection	
M9000405	Articulation kit for side protection	
M9000481	Rear lights support kit	
M9000497	Nebox	
M5341402_80036	Net box support (to be ordered by 2)	
M9001207	Alu corner for reflective tape	
M5332091_80061	Worklight support	
M65031193	LED Worklight 12-24 VDC	
M5329925_80036	DAF truck side light support	
M9001363	Mud guard kit	
M9001198	Back vision kit	SLD3/SLD5

General accessories
Allgemeines Zubehör
Accessoires généraux

Hookloader
Abrollkipper
Polybenne

Skiploader
Absetzkipper
Multibenne

Retrofit kits
Nachrüstungssätze
Kits rétrofit

CITY MOUNTING KIT

CITY MONTAGEBAUSATZ

CITY KIT FIXATION

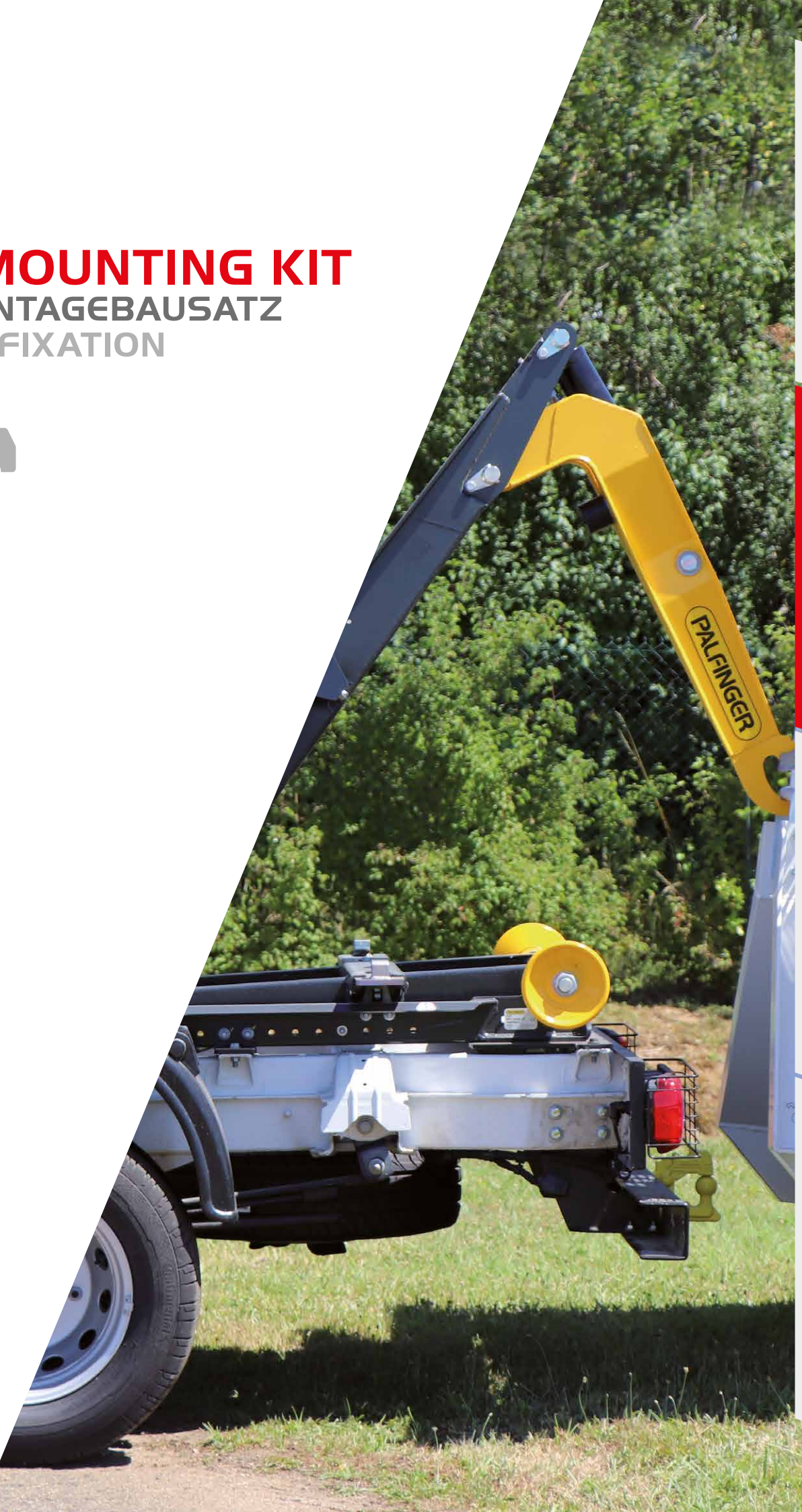

General accessories
Allgemeines Zubehör
Accessoires généraux

Hookloader
Abrollkipper
Polybenne

Skiploader
Absetzkipper
Multibenne

Retrofit kits
Nachrüstungssätze
Kits rétrofit

CITY MOUNTING KIT

CITY MONTAGEBAUSATZ

CITY KIT FIXATION

MAN TGE - VOLKSWAGEN CRAFTER



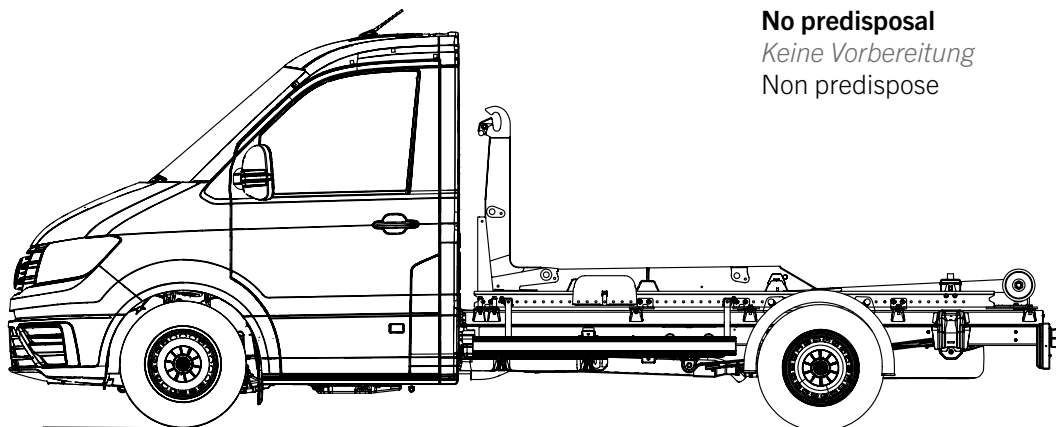

Volkswagen



No predisposal

Keine Vorbereitung

Non predispose

Vehicle (short cab) <i>LKW (kurzes Fahrerhaus)</i> <i>Véhicule (cabine courte)</i>	Wheelbase [mm] <i>Radstand</i> <i>Empattement</i>	Back cab box configuration <i>Ausstattung Fhs Rückwand WZ-Kasten</i> <i>Configuration Coffre dos cabine</i>	Wheel formula <i>/ Radformel /</i> <i>Type de monte</i>	CiTy length [mm] / <i>CiTy Länge /</i> <i>Longueur CiTy</i>		
				2760	2910	3110
MAN TGE Single Tire <i>MAN TGE Einzelreifen</i> <i>MAN TGE monte simple</i>	 3640	without		-	-	M9100045

MAN TGE Twin Tire <i>MAN TGE Doppelreifen</i> <i>MAN TGE monte jumelée</i>	 3640	without		-	-	M9100044
---	---	---------	---	---	---	----------

Designation / <i>Bezeichnung /</i> <i>Désignation</i>	Reference / <i>Referenz /</i> <i>Référence</i>	
	M9100044	M9100045
Mounting kit MAN TGE Twin Tire / <i>Bausatz MAN TGE Doppelreifen /</i> <i>Kit fixation châssis MAN TGE monte jumelée</i>	M9000844	-
Mounting kit MAN TGE Single Tire / <i>Bausatz MAN TGE Einzelreifen /</i> <i>Kit fixation châssis MAN TGE monte simple</i>	-	M9000845
Kit pump NPLH UNI 13 DIN12 / <i>Kit Pumpe NPLH UNI 13 DIN 12 /</i> <i>Kit pompe NPLH UNI 13 Din 12 OMFB</i>	M2375307	
Kit plastic mudguards / <i>Kit Plastik-Kotflügel /</i> <i>Kit ailes plastiques</i>	M9000563	M9000686
Kit side protection MAN TGE 3 / <i>Kit Seitenfahrerschutz MAN TGE 3 /</i> <i>Kit pare-cycliste MAN TGE 3</i>	M9000874	
Kit tank 20 L / <i>Kit 20 L Tank /</i> <i>Kit réservoir 20 L</i>	M2375139	
Kit supports for mudguards or side protection / <i>Kit Halter für Kotflügel oder Seitenfahrerschutz /</i> <i>Kit supports ailes ou pare-cyclistes</i>	M9000566	
Kit short supports for tank / <i>Kit kurze Halter für Tank /</i> <i>Kit supports réservoir courts</i>	M9000567	
Support for working light / <i>Halter für Arbeitsscheinwerfer /</i> <i>Support phare de travail</i>	M5332450_80030	
Screw M12x40 - per 25 / <i>Schraube M12x40 - pro 25 /</i> <i>Vis M12X40 - par 25</i>	M9000587	
Nut M12 - per 25 / <i>Muttern M12 - pro 25 /</i> <i>Ecrou M12 - par 25</i>	M9000588	
M12 Male-Female extension 5 wires 3 m / <i>M12 Stecker Buchse Verlängerung 5-polig - 3 m /</i> <i>Prolongateur M12 Male-Femelle 5 fils 3 m</i>	M65031019	
LED working light / <i>LED Arbeitsscheinwerfer /</i> <i>Phare de travail à LED</i>	M65031193	

MAN TGE - VOLKSWAGEN CRAFTER

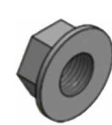
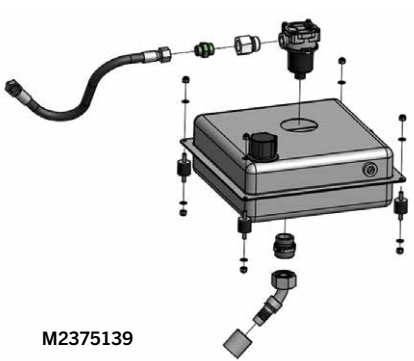
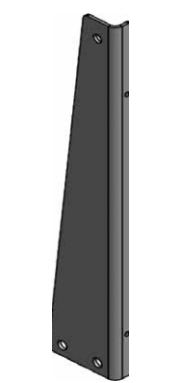
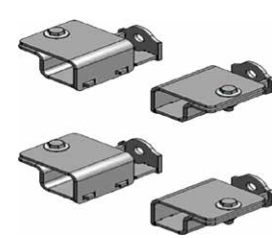
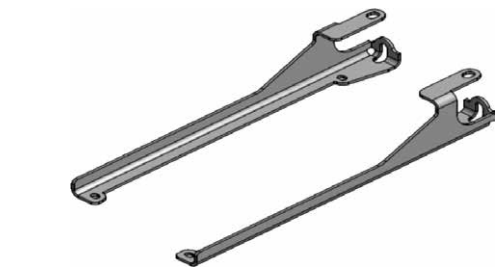
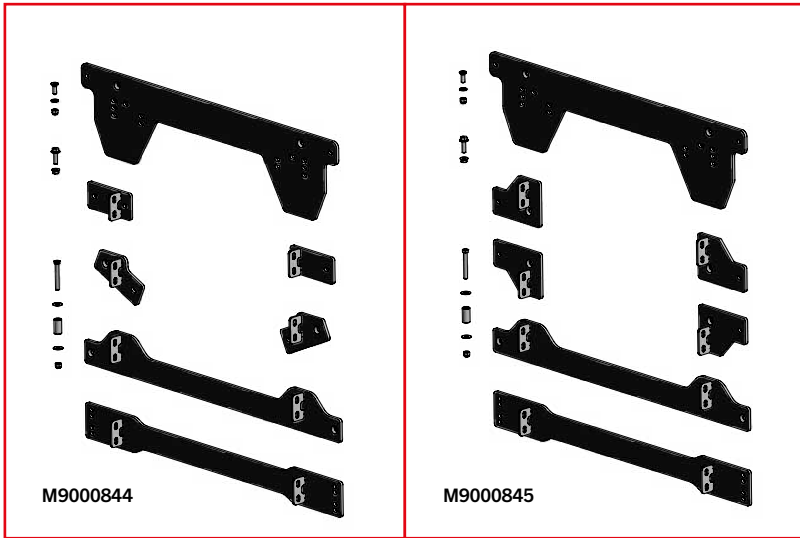

Only for chassis GVW ≤ 3,5 t
 Nur für Fahrgestell ZGG ≤ 3,5 t
 Uniquement pour châssis PTC ≤ 3,5 t

General accessories
 Allgemeines Zubehör
 Accessoires généraux

Hookloader
 Abrollkipper
 Polybenne

Skiploader
 Absetzkipper
 Multibenne

Retrofit kits
 Nachrüstungssätze
 Kits rétrofit

CITY MOUNTING KIT

CITY MONTAGEBAUSATZ

CITY KIT FIXATION

RENAULT MASTER PRO - OPEL MOVANO

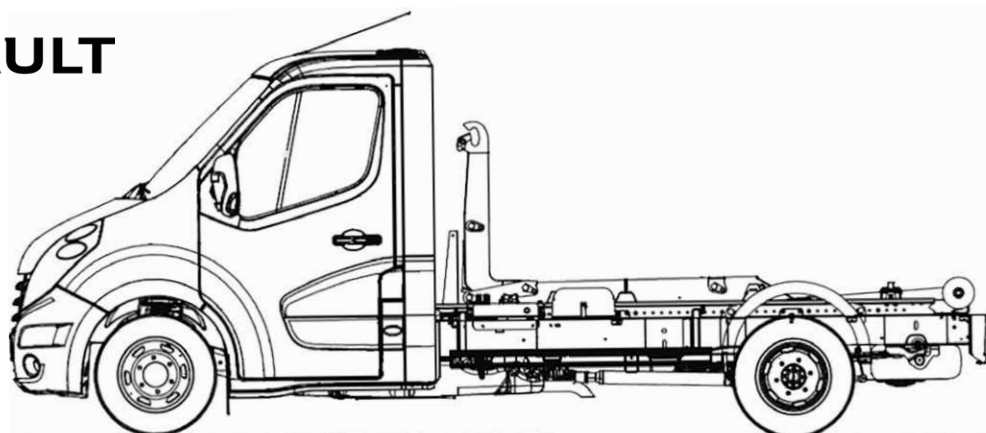

Vehicle (short cab) LKW (kurzes Fahrerhaus) Véhicule (cabine courte)	Wheelbase [mm] Radstand Empattement	Back cab box configuration Ausstattung Fhs Rückwand WZ-Kasten Configuration Coffre dos cabine	CiTy length [mm] / CiTy Länge / Longueur CiTy		
			2760	2910	3110
RENAULT MASTER PRO (twin tires)	3682	without	-	M9100015*	-
	3682	with	-	-	-
	4332	without	-	-	-
	4332	with	-	M9100016	M9100016

* This kit can be ordered directly mounted on the hookloader at the factory, using the option PREDISPOSED MASTER PRO. / Bei Bestellung der Option PREDISPOSED MASTER PRO wird der Montagebausatz bereits ab Werk montiert. / Ce kit peut être commandé directement monté via l'option PREDISPOSED MASTER PRO.

Designation / Bezeichnung / Désignation	Wheel formula / Radformel / Type de monte	Reference Referenz Référence
Full mounting kit MASTER PRO short / Komplettes Aufbaukit MASTER PRO kurz / Kit complet carrossage MASTER PRO court		M9100015
Full mounting kit MASTER PRO long / Komplettes Aufbaukit MASTER PRO lang / Kit complet carrossage MASTER PRO long		M9100016

Designation / Bezeichnung / Désignation	Reference / Referenz / Référence	
	M9100015	M9100016
MASTER PRO Mounting kit short / Bausatz MASTER PRO kurz / Kit fixation châssis MASTER PRO court	M9000543	-
MASTER PRO Mounting kit long / Bausatz MASTER PRO lang / Kit fixation châssis MASTER PRO long	-	M9000574
Kit pump NPLH UNI 13 DIN12 / Kit Pumpe NPLH UNI 13 DIN 12 / Kit pompe NPLH UNI 13 Din 12 OMFB	M2375307	
Kit plastic mudguards / Kit Plastik-Kotflügel / Kit ailes plastiques	M9000563	
Kit side protection / Kit Seitenfahrerschutz / Kit pare-cycliste	M9000565	
Kit tank 20 L / Kit 20 L Tank / Kit réservoir 20 L	M2375139	
Kit supports for mudguards or side protection / Kit Halter für Kotflügel oder Seitenfahrerschutz / Kit supports ailes ou pare-cyclistes	M9000566	
Kit long supports for tank MASTER PRO / Kit lange Halter für Tank MASTER PRO / Kit supports réservoir longs MASTER PRO	M9000568	
Support for working light / Halter für Arbeitsscheinwerfer / Support phare de travail	M5332450_80030	
Screw M12x40 - per 25 / Schraube M12x40 - pro 25 / Vis M12X40 - par 25	M9000587	
Nut M12 - per 25 / Muttern M12 - pro 25 / Ecrou M12 - par 25	M9000588	
LED working light / LED Arbeitsscheinwerfer / Phare de travail à LED	M65031193	

RENAULT MASTER PRO - OPEL MOVANO

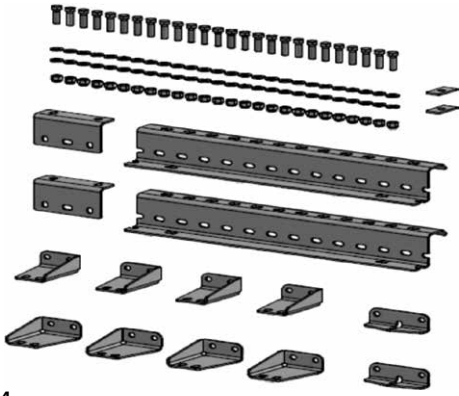

M9000574

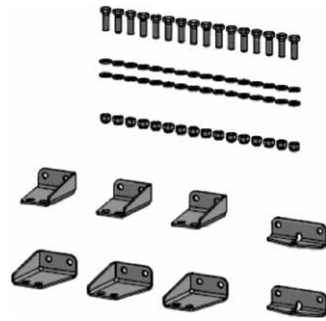

M9000543

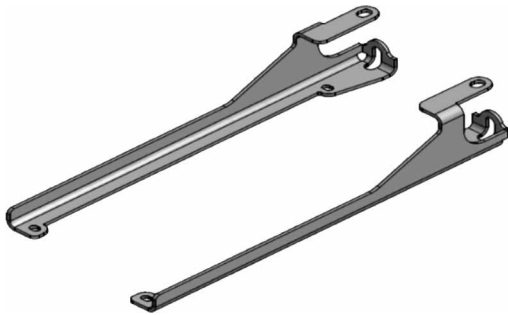

M9000568



M2375307



M9000563



M5332450_80030

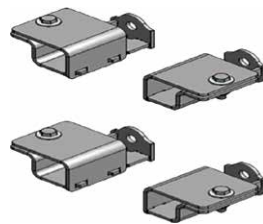

M9000566

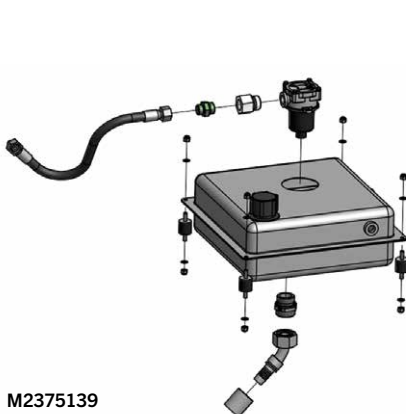

M2375139



M9000587

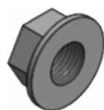

M9000588



Only for chassis GVW ≤ 3,5 t
Nur für Fahrgestell ZGG ≤ 3,5 t
Uniquement pour châssis PTC ≤ 3,5 t

M9000565

CITY MOUNTING KIT

CITY MONTAGEBAUSATZ

CITY KIT FIXATION

IVECO DAILY

IVECO

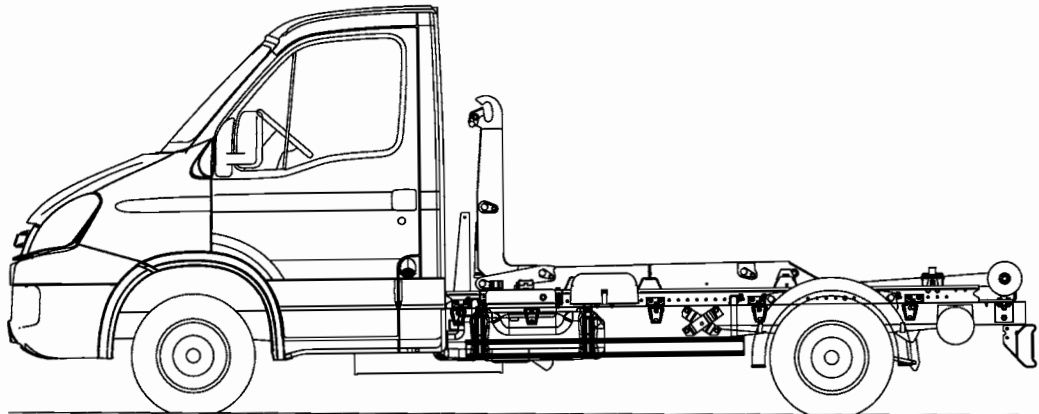

Vehicle (short cab) LKW (kurzes Fahrerhaus) Véhicule (cabine courte)	Wheelbase [mm] Radstand Empattement	Back cab box configuration Ausstattung Fhs Rückwand WZ-Kasten Configuration Coffre dos cabine	CiTy length [mm] / CiTy Länge / Longueur CiTy		
			2760	2910	3110
IVECO DAILY	3000	without	M9100019	-	-
	3450	without	-	M9100019*	M9100019*
	3750	without	-	M9100020	M9100020
	3750	with	M9100020	M9100020	-
	4100	with	M9100020	M9100020	M9100020

* This kit can be ordered directly mounted on the hookloader at the factory, using the option **PREDISPOSED IVECO DAILY**. / Bei Bestellung der Option **PREDISPOSED IVECO DAILY** wird der Montagebausatz bereits ab Werk montiert. / Ce kit peut être commandé directement monté via l'option **PREDISPOSED IVECO DAILY**.

Designation / Bezeichnung / Désignation	Wheel formula / Radformel / Type de monte	Reference Referenz Référence
Full mounting kit DAILY short / Komplettes Aufbaukit DAILY kurz / Kit complet carrossage DAILY court		M9100019
Full mounting kit DAILY long / Komplettes Aufbaukit DAILY lang / Kit complet carrossage DAILY long		M9100020

Designation / Bezeichnung / Désignation	Reference / Referenz / Référence
	M9100019 M9100020
Mounting kit DAILY short / Bausatz DAILY kurz / Kit fixation châssis DAILY court	M9000547 -
Mounting kit DAILY long / Bausatz DAILY lang / Kit fixation châssis DAILY long	- M9000573
Kit pump NPLH UNI 13 DIN12 / Kit Pumpe NPLH UNI 13 DIN 12 / Kit pompe NPLH UNI 13 Din 12 OMFB	M2375307
Kit plastic mudguards / Kit Plastik-Kotflügel / Kit ailes plastiques	M9000563
Kit side protection / Kit Seitenfahrerschutz / Kit pare-cycliste	M9000565
Kit tank 20 L / Kit 20 L Tank / Kit réservoir 20 L	M2375139
Kit supports for mudguards or side protection / Kit Halter für Kotflügel oder Seitenfahrerschutz / Kit supports ailes ou pare-cyclistes	M9000566
Kit short supports for tank / Kit kurze Halter für Tank / Kit supports réservoir courts	M9000567
Support for working light / Halter für Arbeitsscheinwerfer / Support phare de travail	M5332450_80030
Kit spare wheel support / Kit Halter für Reserverad / Kit support porte roue de secours	M9000576
Screw M12x40 - per 25 / Schraube M12x40 - pro 25 / Vis M12X40 - par 25	M9000587
Nut M12 - per 25 / Muttern M12 - pro 25 / Ecrou M12 - par 25	M9000588
LED working light / LED Arbeitsscheinwerfer / Phare de travail à LED	M65031193

IVECO DAILY

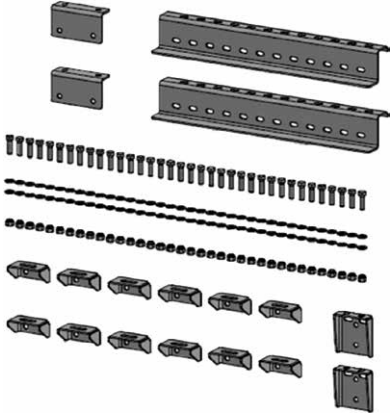

M9000573

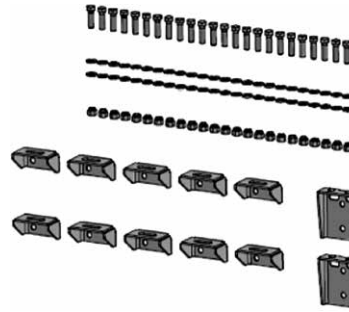

M9000547



M9000563



M2375307

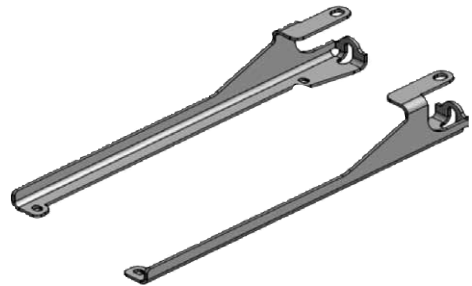

M9000567

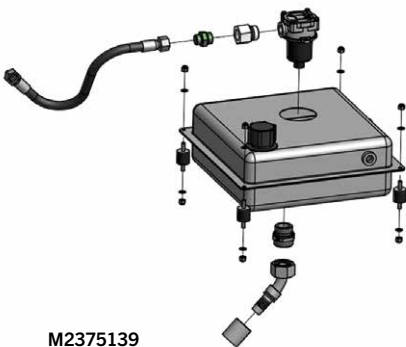

M2375139

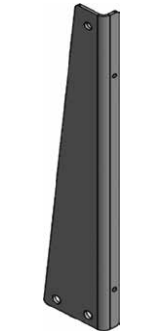

M5332450_80030



M65031193

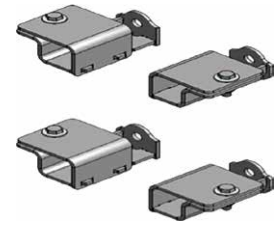

M9000566



M9000587

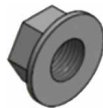

M9000588



Only for chassis GVW ≤ 3,5 t
 Nur für Fahrgestell ZGG ≤ 3,5 t
 Uniquement pour châssis PTC ≤ 3,5 t

M9000565

CITY MOUNTING KIT

CITY MONTAGEBAUSATZ

CITY KIT FIXATION

FUSO CANTER 3CXX - 2022

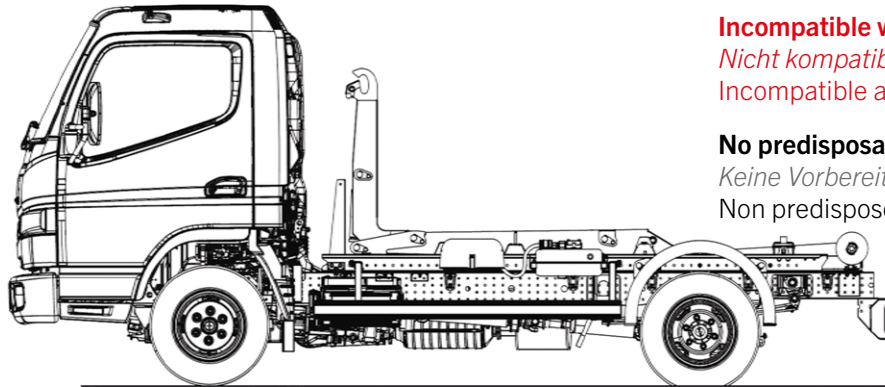

Incompatible with 3S chassis
Nicht kompatibel mit 3S Chassis
Incompatible avec châssis 3S

No predisposal
Keine Vorbereitung
Non predispose

Vehicle (short cab) <i>LKW (kurzes Fahrerhaus)</i> <i>Véhicule (cabine courte)</i>	Wheelbase [mm] <i>Radstand</i> <i>Empattement</i>	Back cab box configuration <i>Ausstattung Fhs Rückwand WZ-Kasten</i> <i>Configuration Coffre dos cabine</i>	CiTy length [mm] / <i>CiTy Länge</i> / <i>Longueur CiTy</i>		
			2760	2910	3110
FUSO CANTER 3Cxx	2500	without	M9100055	M9100055	-
	2800	without	-	M9100055	M9100055
	2800	with	M9100056	-	-
	3400	without	-	-	-
	3400	with	M9100056	M9100056	M9100056
	3850	without	-	-	-
	3850	with	-	-	-

Designation / <i>Bezeichnung</i> / <i>Désignation</i>	Wheel formula <i>Radformel</i> / <i>Type de monte</i>	Reference / <i>Referenz</i> / <i>Référence</i>
Full mounting kit FUSO CANTER short / <i>Komplettes Aufbaukit FUSO CANTER kurz</i> / <i>Kit complet carrossage FUSO CANTER court</i>		M9100055
Full mounting kit FUSO CANTER long / <i>Komplettes Aufbaukit FUSO CANTER lang</i> / <i>Kit complet carrossage FUSO CANTER long</i>		M9100056

Designation / <i>Bezeichnung</i> / <i>Désignation</i>	Reference / <i>Referenz</i> / <i>Référence</i>	
	M9100055	M9100056
FUSO CANTER Mounting kit short / <i>FUSO CANTER kurz</i> / <i>Kit fixation châssis FUSO CANTER court</i>	M9001326	-
FUSO CANTER Mounting kit long / <i>FUSO CANTER lang</i> / <i>Kit fixation châssis FUSO CANTER long</i>	-	M9001327
Kit pump OMFB 12cc + ISO adapter / <i>Kit pump OMFB 12cc + ISO adapter</i> / <i>Kit pump OMFB 12cc + ISO adapter</i>	M2375310	
Kit plastic mudguards / <i>Kit Plastik-Kotflügel</i> / <i>Kit ailes plastiques</i>	M9000563	
Kit side protection / <i>Kit Seitenfahrerschutz</i> / <i>Kit pare-cycliste</i>	M9000642	
Kit tank 20 L / <i>Kit 20 L Tank</i> / <i>Kit réservoir 20 L</i>	M2375345	
Kit supports for mudguards or side protection / <i>Kit Halter für Kotflügel oder Seitenfahrerschutz</i> / <i>Kit supports ailes ou pare-cyclistes</i>	M9000566	
Kit short supports for tank / <i>Kit kurze Halter für Tank</i> / <i>Kit supports réservoir courts</i>	M9000567	
Support for working light / <i>Halter für Arbeitsscheinwerfer</i> / <i>Support phare de travail</i>	M5332450_80030	
Kit spare wheel support / <i>Kit Halter für Reserverad</i> / <i>Kit support porte roue de secours</i>	M9000644	
Screw M10x40 - per 25 / <i>Schraube M10x40 - pro 25</i> / <i>Vis M10x40 - par 25</i>	M9000589	
Nut M10 - per 25 / <i>Muttern M10 - pro 25</i> / <i>Ecrou M10 - par 25</i>	M9000597	
LED working light / <i>LED Arbeitsscheinwerfer</i> / <i>Phare de travail à LED</i>	M65031193	
M12 Male-Female extension 5 wires 3 m / <i>M12 Stecker Buchse Verlängerung 5-polig - 3 m</i> / <i>Prolongateur M12 Male-Femelle 5 fils 3 m</i>	M65031019	

FUSO CANTER 3CXX

M9001326

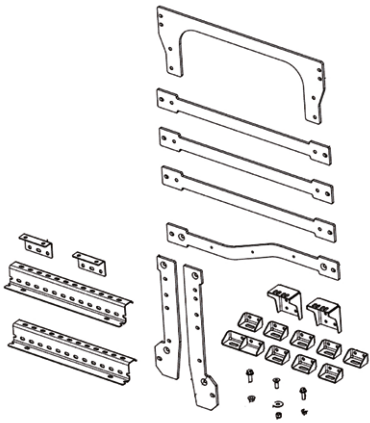

M9001327

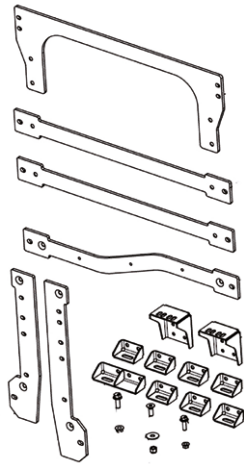

M65031019



M2375310



M9000567



M5332450_80030

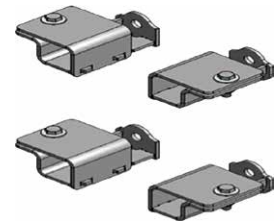

M9000566

M9000563



M2375345

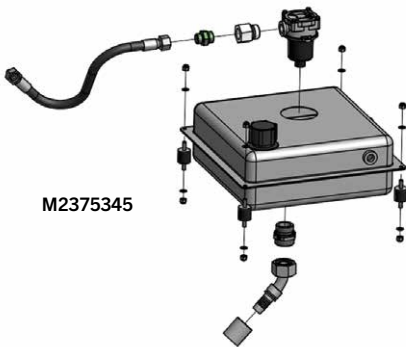

M65031193



M9000589



M9000644

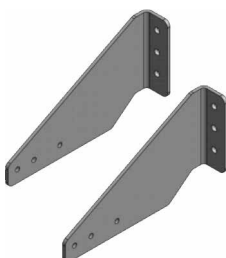

M9000590



M9000642

Only for chassis GVW ≤ 3,5 t
Nur für Fahrgestell ZGG ≤ 3,5 t
Uniquement pour châssis PTC ≤ 3,5 t

CITY MOUNTING KIT

CITY MONTAGEBAUSATZ

CITY KIT FIXATION

MERCEDES SPRINTER 3XX CDI - 5XX



Mercedes-Benz

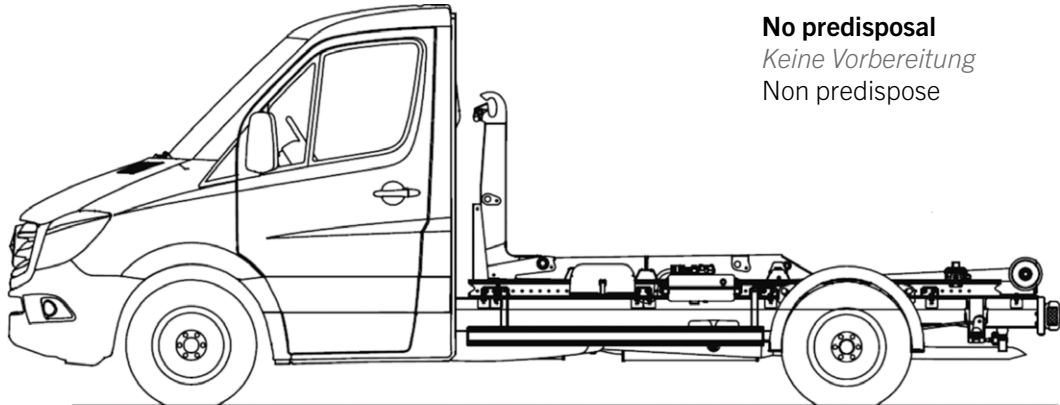

No predisposal

Keine Vorbereitung

Non predispose

Vehicle (short cab) <i>LKW (kurzes Fahrerhaus)</i> Véhicule (cabine courte)	Wheelbase [mm] <i>Radstand</i> Empattement	Back cab box configuration <i>Ausstattung Fhs Rückwand WZ-Kasten</i> Configuration Coffre dos cabine	City length [mm] <i>City Länge</i> Longueur City
MERCEDES SPRINTER 3xx CDI	3665	without	3110

Designation / Bezeichnung / Désignation	Wheel formula / <i>Radformel /</i> Type de monte	Reference <i>Referenz</i> Référence
Full mounting kit MB SPRINTER 3xxCDI single tire <i>Komplettes Aufbaukit MB SPRINTER 3xxCDI Einzelreifen</i> Kit complet carrossage MB SPRINTER 3xx CDI monte simple		M9100038
Full mounting kit MB SPRINTER 3xxCDI twin tire <i>Komplettes Aufbaukit MB SPRINTER 3xxCDI Doppelreifen</i> Kit complet carrossage MB SPRINTER 3xx CDI monte jumelée		M9100049

Designation / Bezeichnung / Désignation	Reference / Referenz / Référence
Mounting kit MB SPRINTER 3xx single tire / Bausatz MB SPRINTER 3xx Einzelreifen / Kit de fixations MB SPRINTER 3xx monte simple	M9000658 -
Mounting kit MB SPRINTER 3xxCDI twin tire / Bausatz MB SPRINTER 3xxCDI Doppelreifen / Kit de fixations MB SPRINTER 3xx CDI monte jumelée	- M9001181
Kit pump NHLP20+ADAPT 4 points ISO MB / Kit Pumpe NHLP 20+ Adapt. 4 pts ISO MB / Kit pompe NHLP 20+ADAPT 4 pts ISO MB	M2375311
Kit Plastic mudguards / Kit Plastik-Kotflügel / Kit Ailes plastiques	M9000686 M9000563
Kit Side protection / Kit Seitenfahrerschutz / Kit pare-cycliste	M9000687
Kit tank 20 L / Kit 20 L Tank / Kit réservoir 20 L	M2375139
Kit supports for mudguards or side protection / Kit Halter für Kotflügel oder Seitenfahrerschutz / Kit supports ailes ou pare-cyclistes	M9000566
Kit short supports for tank / Kit kurze Halter für Tank / Kit supports réservoir courts	M9000567
Support for working light / Halter für Arbeitsscheinwerfer / Support phare de travail	M5332450_80030
Screw M12x40 - per 25 / Schraube M12x40 - pro 25 / Vis M12x40 - par 25	M9000587
Nut M12 - per 25 / Muttern M12 - pro 25 / Ecrou M12 - par 25	M9000588
LED working light / LED Arbeitsscheinwerfer / Phare de travail à LED	M65031193
Kit Hose support / Kit Schlauchhalter / Kit support flexible	M2375168
M12 Male-Female extension 5 wires 3 m / M12 Stecker Buchse Verlängerung 5-polig 3 m / Prolongateur M12 Male-Femelle 5 fils 3 m	M65031019

MERCEDES SPRINTER 3XX CDI - 5XX

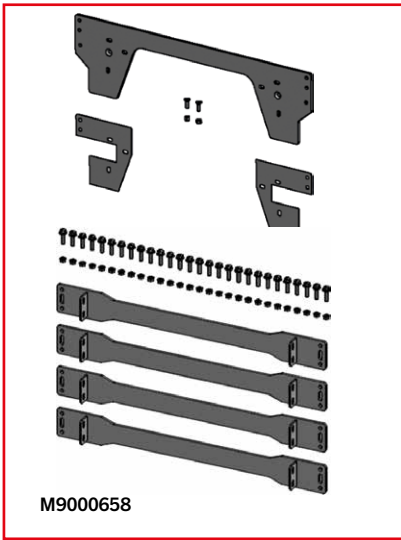

M9000658

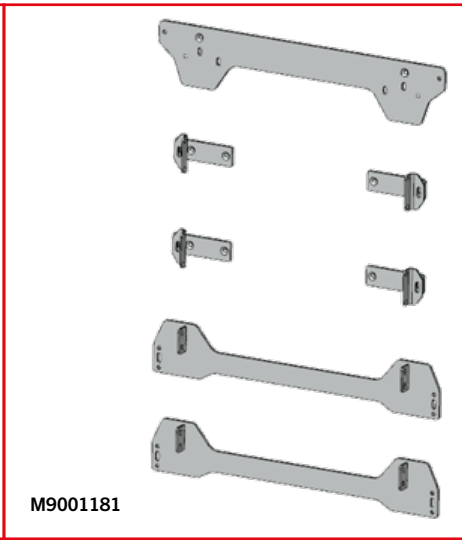

M9001181

M2375168

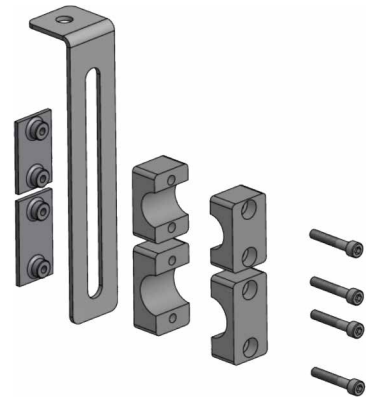

M65031193



M65031019



M9000567



M2375311

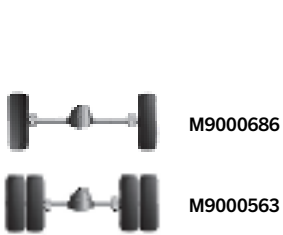

M9000686

M9000563



M9000566

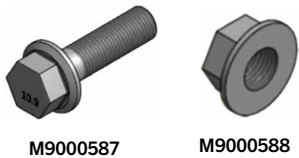

M9000587

M9000588

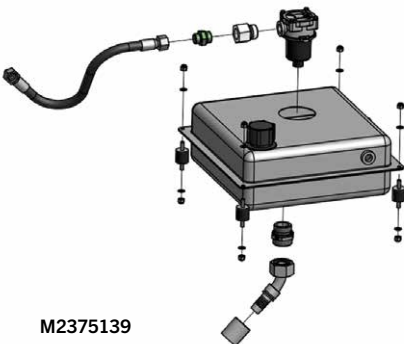
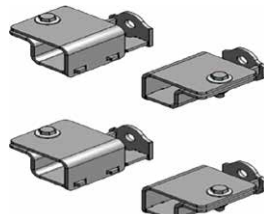

M2375139



M5332450_80030



M9000687

Only for chassis GVW ≤ 3,5 t
Nur für Fahrgestell ZGG ≤ 3,5 t
Uniquement pour châssis PTC ≤ 3,5 t

General accessories
Allgemeines Zubehör
Accessoires généraux

Hookloader
Abrollkipper
Polybenne

Skiploader
Absetzkipper
Multibenne

Retrofit kits
Nachrüstungssätze
Kits rétrofit

CITY MOUNTING KIT

CITY MONTAGEBAUSATZ

CITY KIT FIXATION

FIAT DUCATO - PEUGEOT BOXER - CITROEN JUMPER

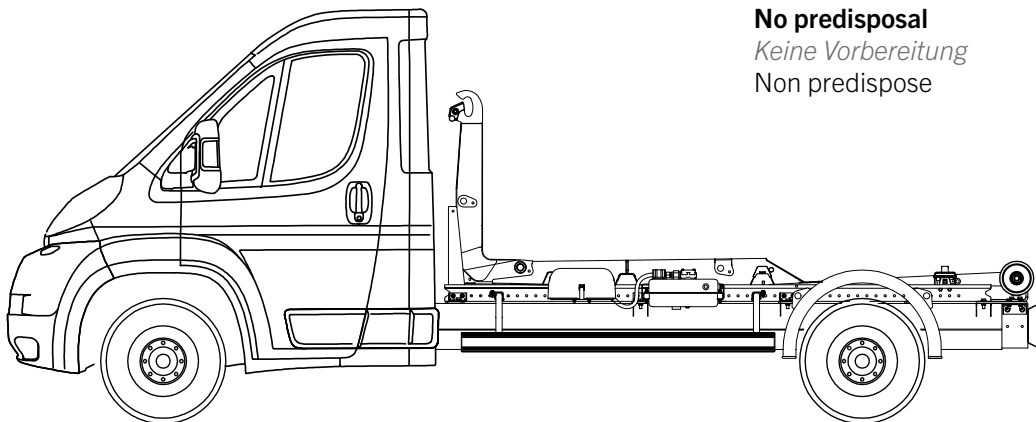

No predisposal

Keine Vorbereitung

Non predispose

Vehicle (short cab) <i>LKW (kurzes Fahrerhaus)</i> <i>Véhicule (cabine courte)</i>	Wheel formula / <i>Radformel /</i> <i>Type de monte</i>	Wheelbase [mm] <i>Radstand</i> <i>Empattement</i>	Back cab box configuration <i>Ausstattung Fhs Rückwand WZ-Kasten</i> <i>Configuration Coffre dos cabine</i>	City length [mm] <i>City Länge</i> <i>Longueur City</i>
FIAT DUCATO		3800	without	3110

Designation / <i>Bezeichnung / Désignation</i>	Reference / <i>Referenz / Référence</i>
Mounting kit FIAT DUCATO / <i>Bausatz FIAT DUCATO / Kit de fixations FIAT DUCATO</i>	M9000791
Power pack 12 V / <i>POWER PACK 12 V / Groupe electro pompe 12 V</i>	M2375128
Kit 20 L Tank / <i>Bausatz 20 L Tank / Kit 20 L réservoir</i>	M2375139
Kit Plastic mudguards / <i>Bausatz Plastik-Kotflügel / Kit Ailes plastiques</i>	M9000686
Kit Side protection / <i>Bausatz Seitenfahrerschutz / Kit pare-cycliste</i>	M9000687
Kit supports for mudguards or side protection / <i>Kit Halter für Kotflügel oder Seitenfahrerschutz / Kit supports ailes ou pare-cyclistes</i>	M9000566
Tank Support / <i>Tankhalter / Support réservoir</i>	M5334486_80
Support for working light / <i>Halter für Arbeitsscheinwerfer / Support phare de travail</i>	M5332450_80030
Screw M12x40 - per 25 / <i>Schraube M12x40 - pro 25 / Vis M12x40 - par 25</i>	M9000587
Nut M12 - per 25 / <i>Muttern M12 - pro 25 / Ecrou M12 - par 25</i>	M9000588
LED working light / <i>LED Arbeitsscheinwerfer / Phare de travail à LED</i>	M65031193

FIAT DUCATO - PEUGEOT BOXER - CITROEN JUMPER

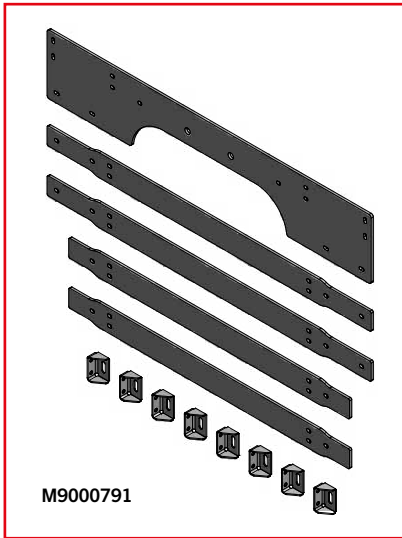

M9000791



M5332450_80030



M65031193

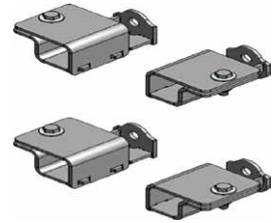

M9000566



M9000686



M9000587



M9000588



Only for chassis GVW ≤ 3,5 t
Nur für Fahrgestell ZGG ≤ 3,5 t
Uniquement pour châssis PTC ≤ 3,5 t

M9000687

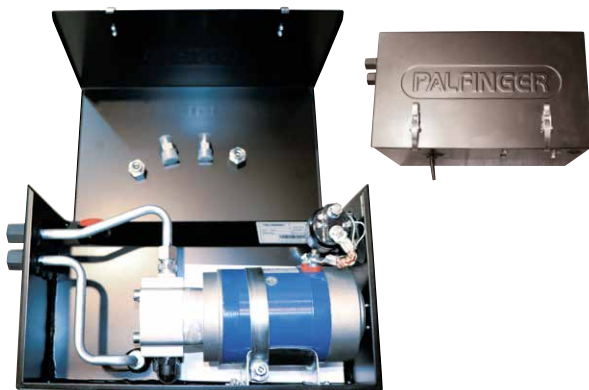

M2375128

CITY MOUNTING KIT

CITY MONTAGEBAUSATZ

CITY KIT FIXATION

UNIVERSAL / Universal / Universel

Designation / Bezeichnung / Désignation	Reference Referenz Référence
UNIVERSAL Mounting kit / Bausatz UNIVERSAL / Kit fixation châssis UNIVERSEL	M9000579
Kit pump NPLH UNI 13 DIN12 / Kit Pumpe NPLH UNI 13 DIN 12 / Kit pompe NPLH UNI 13 Din 12 OMFB	M2375307
Kit plastic mudguards for twin tyre / Kit Plastik-Kotflügel / Kit ailes plastiques monte jumelée	M9000563
Kit plastic mudguards for single tyre / Kit Plastik-Kotflügel / Kit ailes plastiques monte simple	M9000686
Kit side protection MASTER PRO - DAILY / Kit Seitenfahrerschutz MASTER PRO - DAILY / Kit pare-cycliste MASTER PRO - DAILY	M9000565
Kit tank 20 L / Kit 20 L Tank / Kit réservoir 20 L CiTy	M2375139
Kit supports for mudguards or side protection / Kit Halter für Kotflügel oder Seitenfahrerschutz / Kit supports ailes ou pare-cyclistes	M9000566
Kit short supports for tank MAXITY / DAILY / Kit kurze Halter für Tank MAXITY / DAILY / Kit supports réservoir courts MAXITY / DAILY	M9000567
Support for working light / Halter für Arbeitsscheinwerfer / Support phare de travail	M5332450_80030
Screw M12x40 - per 25 / Schraube M12x40 - pro 25 / Vis M12x40 - par 25	M9000587
Nut M12 - per 25 / Muttern M12 - pro 25 / Ecrou M12 - par 25	M9000588
M12 Male-Female extension 5 wires 3 m / M12 Stecker Buchse Verlängerung 5-polig - 3 m / Prolongateur M12 Male-Femelle 5 fils 3 m	M65031019
LED working light / LED Arbeitsscheinwerfer / Phare de travail à LED	M65031193

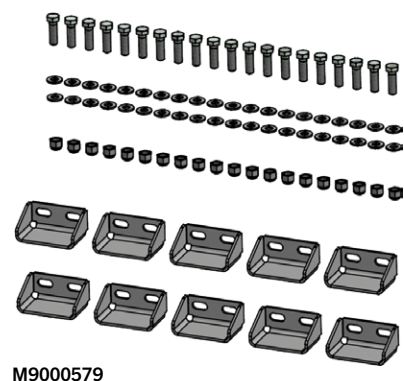

Only for chassis GVW ≤ 3,5 t
Nur für Fahrgestell ZGG ≤ 3,5 t
Uniquement pour châssis PTC ≤ 3,5 t

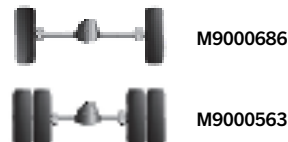
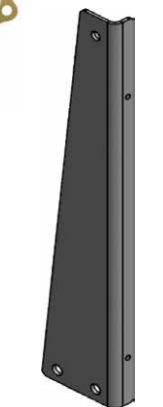
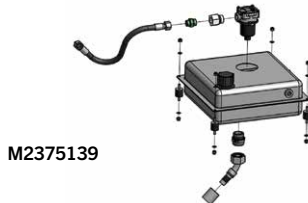
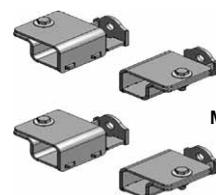
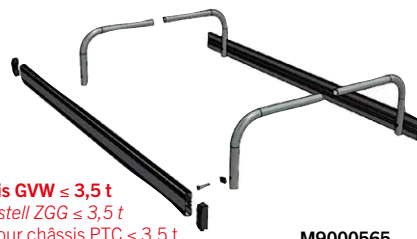

MISCELLANEOUS

SONSTIGES

DIVERS

BACK CAB BOX / Rückwand Werkzeugkasten / Coffre dos cabine

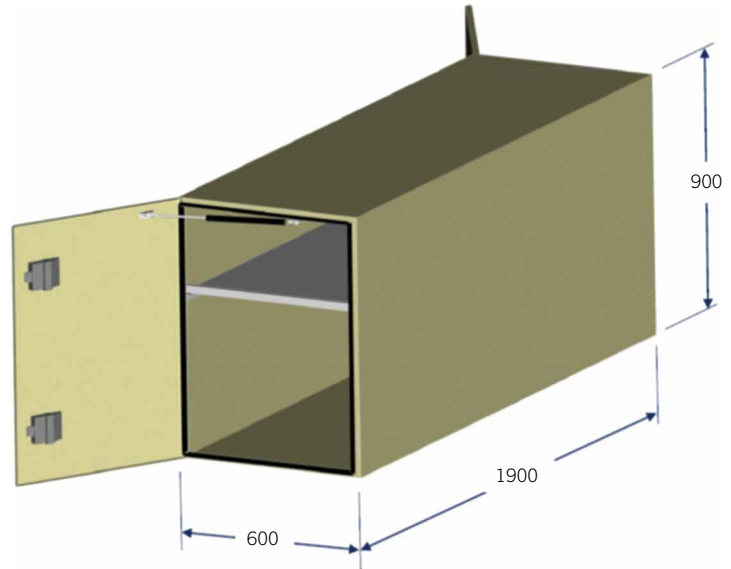

Designation / Bezeichnung / Désignation



Reference
Referenz
Référence

Aluminium back cab box
Aluminium Werkzeugkasten (Rückwand)
Coffre Aluminium dos cabine

63

M9000660

General accessories
Allgemeines Zubehör
Accessoires généraux

Hookloader
Abrollkipper
Polybenne

Skiploader
Absetzkipper
Multibenne

Retrofit kits
Nachrüstungssätze
Kits rétrofit



MISCELLANEOUS

SONSTIGES

DIVERS

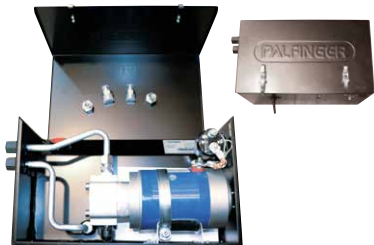
POWER PACK / Power Pack / Kit électro-pompe



Designation Bezeichnung Désignation	Reference Referenz Référence	Lifting capacity [t] Ladekapazität Capacité de levage	 [mm]	 kg
Power Pack 12 V Power Pack 12 V Kit électro-pompe 12 V	M2375128	< 4	440x231x280	14
Power Pack 24 V Power Pack 24 V Kit électro-pompe 24 V	M2375129	< 4	440x231x280	14

Hydraulic / Electric Schematic

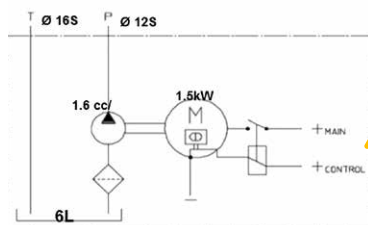

In case of Power pack 12 VDC, the loading capacity is decreased of about 40%

Mit Power Pack 12 VDC die Hubkapazität wird von etwa 40% reduziert

Dans le cas d'un groupe électro-pompe 12 VDC, la capacité de levage est réduite de 40%

POWER SUPPLY CABLE POWER PACK / NETZTEILKABEL Power Pack / Câble alimentation électro-pompe



Reference Referenz Référence	Section [mm ²] Sektion Section	Length [mm] Länge Longueur	Voltage[VDC] Stromspannung Tension
EEA16408	70	3000	12 / 24

SKIPLoader INSTALLATION

ABSETZKIPPER AUFBAU INSTALLATION MULTIBENNE

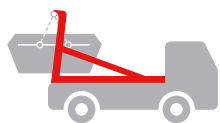

General accessories
Allgemeines Zubehör
Accessoires généraux

Hookloader
Abrollkipper
Polybenne

Skiploader
Absetzkipper
Multibenne

Retrofit kits
Nachrüstungssätze
Kits retrofit

TARP SYSTEM PALCOVER S

PLANENSYSTEME PALCOVER S SYSTÈME DE BÂCHAGE PALCOVER S

	Designation / Bezeichnung / Désignation	Reference Referenz Référence	kg
<p>PALCOVER S-E</p> 	<p>PALCOVER S-E with tarp - net without flaps <i>PALCOVER S-E mit Plane - Netz ohne Laschen</i> PALCOVER S-E bâche filet sans rabats</p> <p>Not possible with option 9601 <i>Mit Option 9601 nicht möglich</i> pas possible avec option 9601</p>	<p>M9000793</p>	<p>200</p>
<p>PALCOVER S-M</p> 	<p>PALCOVER S-M with tarp - net without flaps <i>PALCOVER S-M mit Plane - Netz ohne Laschen</i> PALCOVER S-M bâche filet sans rabats</p> <p>Not possible with option 9601 <i>Mit Option 9601 nicht möglich</i> pas possible avec option 9601</p>	<p>M9000792</p>	<p>195</p>
<p>PALCOVER SA-F</p> 	<p>PALCOVER SA-F(fix) with tarp - net without flaps <i>PALCOVER SA-F(fix) mit Plane - Netz ohne Laschen</i> PALCOVER SA-F(fixe) bâche filet sans rabats</p> <p>9601+ 9639 skiploader option required <i>9601+ 9639 Option für Absetzkipper erforderlich</i> 9601+ 9639 option nécessaire sur le multibenne</p> <p>Not compatible with PST18 L5600</p>	<p>M9000799</p>	<p>214</p>
<p>PALCOVER SA-T</p> 	<p>PALCOVER SA-T (telescopic) with tarp - net without flaps <i>PALCOVER SA-T (teleskopisch) mit Plane - Netz ohne Laschen</i> PALCOVER SA-T (telescopique) bâche filet sans rabats</p> <p>9601+ 9639 skiploader option required <i>9601+ 9639 Option für Absetzkipper erforderlich</i> 9601+ 9639 option nécessaire sur le multibenne</p> <p>Not compatible with PST18 L5600</p>	<p>M9000794</p>	<p>323</p>
	<p>Kit back cab. Tank 120 L+support for Palcover S-E / S-M / SA-T <i>Fhs Rückwand Tank 120 L + Halter für Palcover S-E / S-M / SA-T</i> Kit réservoir 120 L + support pour Palcover S-E / S-M / SA-T</p>	<p>M9000801</p>	<p>-</p>
	<p>RRC for PALCOVER H-E / S-E / SA-T <i>FFS für PALCOVER H-E / S-E / SA-T</i> Radio commande pour PALCOVER H-E / S-E / SA-T</p>	<p>M65031117</p>	<p>-</p>
	<p>Tarp - net without flaps <i>Plane - Netz ohne Laschen</i> Bâche filet sans rabats</p>	<p>SM -SE SAT -SAF</p> <p>M2391020 M2391016</p>	<p>18</p>

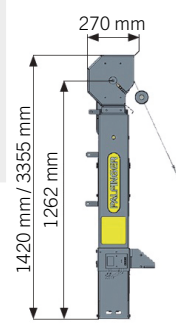

* product info on <https://extranet.palfinger.com/paldesk/product-information>



SKIPLOADER MOUNTING KIT

ABSETZKIPPER MONTAGEBAUSATZ

MULTIBENNE KIT FIXATION

RENAULT T-K-C / VOLVO FMX-FH-FM



Incompatible with option code **FRAME266**

Nicht kompatibel mit option code FRAME266.

Incompatible avec code option FRAME266.

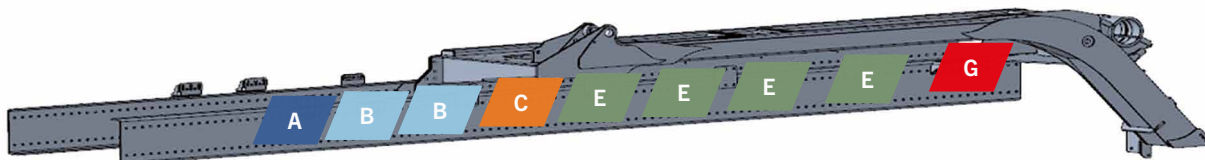

Diameter Durchmesser Diamètre (mm)	40	50	60	80	100	Nuts Nüsse Ecrus
---	----	----	----	----	-----	------------------------



Ø14

M9000464
(qty 50/box)

M9000465
(qty 50/box)

-

M9001032
(qty 25/box)

M9001033
(qty 25/box)

M9000463
qty (100/box)

PS T 14 - 18

	A	B	C	D	E	F	G	Bolts / Schrauben / Visserie	
			-	-		-			
M9001054	PS T 14/18 < 4500 + screws / Schrauben / Visserie	x1	x1	-	-	x4	-	x1	
M9001055	PS T 14/18 ≥ 4500 + screws / Schrauben / Visserie	x1	x1	-	-	x5	-	x1	
M9001052	PS T 14/18 < 4500	x1	x1	-	-	x4	-	x1	
M9001053	PS T 14/18 ≥ 4500	x1	x1	-	-	x5	-	x1	
Retailed kits	-	-	-	-	M9000887	-	M9000523		

MAN TGA - TGS - TGX

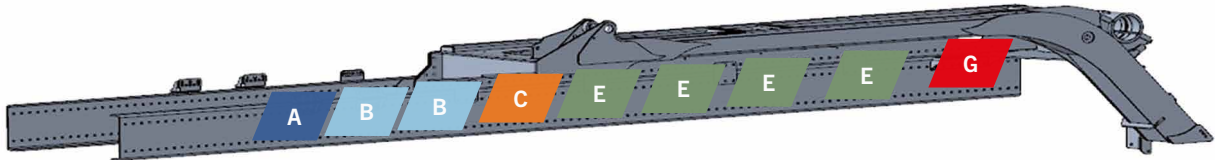





Diameter Durchmesser Diamètre (mm)	Length / Länge / Longueur (mm)					Nuts Nüsse Ecrus
	40	50	60	80	100	
Ø14	M9000464 (qty 50/box)	M9000465 (qty 50/box)	-	M9001032 (qty 25/box)	M9001033 (qty 25/box)	M9000463 qty (100/box)



PS T 14 - 18

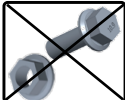

		A	B	C	D	E	F	G	Bolts / Schrauben / Visserie
M9001058	PS T 14/18 < 4500 + screws / Schrauben / Visserie	x1	x1	x2	-	x2	-	x1	
M9001059	PS T 14/18 ≥ 4500 + screws / Schrauben / Visserie	x1	x1	x2	-	x3	-	x1	
M9001056	PS T 14/18 < 4500	x1	x1	x2	-	x2	-	x1	
M9001057	PS T 14/18 ≥ 4500	x1	x1	x2	-	x3	-	x1	
Retailed kits		-	-	-	-	M9000902	-	M9000772	

SKIPLOADER MOUNTING KIT

ABSETZKIPPER MONTAGEBAUSATZ



MULTIBENNE KIT FIXATION

MERCEDES ACTROS NEW, ANTOS & AROCS - SPRING SUSPENSION / *Stahlfederung* / *Suspension mécanique*



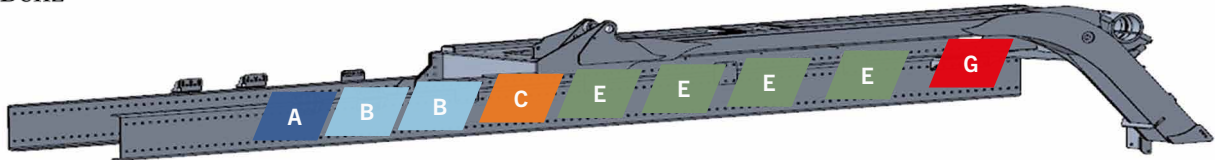









Mercedes-Benz



	Diameter Durchmesser Diamètre (mm)		Length / Länge / Longueur (mm)					Nuts Nüsse Ecrous
	40	50	60	80	100			
	Ø14	M9000464 (qty 50/box)	M9000465 (qty 50/box)	-	M9001032 (qty 25/box)	M9001033 (qty 25/box)	M9000463 qty (100/box)	
	Ø16	-	M9000505 (qty 50/box)	M9000506 (qty 50/box)	M9001128 (qty 25/box)	M9001129 (qty 25/box)	M9000507 (qty 100/box)	

PS T 14 - 18

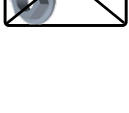
	A	B	C	D	E	F	G	Bolts / Schrauben / Visserie	
				-		-			
M9001062	PS T 14/18 < 4500 + screws / Schrauben / Visserie	x1	X1	x1	-	x3	-	x1	
M9001063	PS T 14/18 ≥ 4500 + screws / Schrauben / Visserie	x1	x1	x1	-	x4	-	x1	
M9001060	PS T 14/18 < 4500	x1	X1	x1	-	x3	-	x1	
M9001061	PS T 14/18 ≥ 4500	x1	x1	x1	-	x4	-	x1	
Retailed kits	-	-	-	-	M9000910	-	M9000650		

MERCEDES ACTROS NEW, ANTOS & AROCS - AIR SUSPENSION / Luftfederung / Suspension pneumatique



Mercedes-Benz

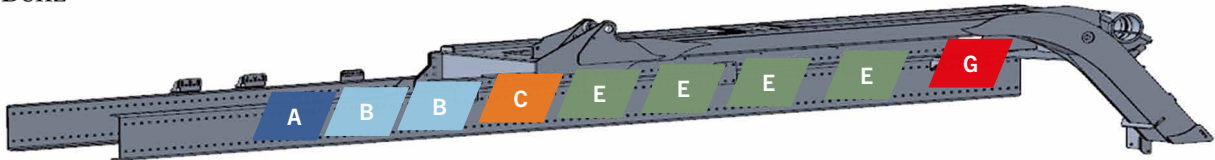

Diameter Durchmesser Diamètre (mm)	Length / Länge / Longueur (mm)					Nuts Nüsse Ecrous
	40	50	60	80	100	
Ø14	M9000464 (qty 50/box)	M9000465 (qty 50/box)	-	-	-	M9000463 qty (100/box)
Ø16	-	M9000505 (qty 50/box)	M9000506 (qty 50/box)	-	-	M9000507 (qty 100/box)

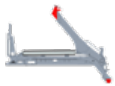

PS T 14 - 18

	A	B	C	D	E	F	G	Bolts / Schrauben / Visserie
M9001066				-		-		
PS T 14/18 < 4500 + screws / Schrauben / Visserie	x1	X1	x1	-	x4	-	x1	
M9001067				-		-		
PS T 14/18 ≥ 4500 + screws / Schrauben / Visserie	x1	x1	x1	-	x5	-	x1	
M9001064				-		-		
PS T 14/18 < 4500	x1	X1	x1	-	x4	-	x1	
M9001065				-		-		
PS T 14/18 ≥ 4500	x1	x1	x1	-	x5	-	x1	
Retailed kits	-	-	-	-	M9000920	-	M9000523	

General accessories
Allgemeines Zubehör
Accessoires généraux

Hookloader
Abrollkipper
Polybenne

Skiploader
Absetzkipper
Multibenne

Retrofit kits
Nachrüstungssätze
Kits rétrofit

SKIPLOADER MOUNTING KIT

ABSETZKIPPER MONTAGEBAUSATZ

MULTIBENNE KIT FIXATION

IVECO S WAY - X WAY

IVECO

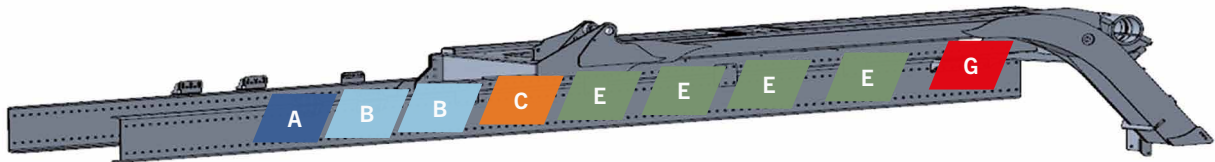

Diameter Durchmesser Diamètre (mm)	40	50	60	80	100	Nuts Nüsse Ecrous
---	----	----	----	----	-----	-------------------------



Ø14	M9000464 (qty 50/box)	M9000465 (qty 50/box)	-	M9001032 (qty 25/box)	M9001033 (qty 25/box)	M9000463 qty (100/box)
-----	--------------------------	--------------------------	---	--------------------------	--------------------------	---------------------------

PS T 14 - 18

	A	B	C	D	E	F	G	Bolts / Schrauben / Visserie
--	---	---	---	---	---	---	---	------------------------------



M9001074	PS T 14/18 < 4500 + screws / Schrauben / Visserie	x1	x2	x1	-	x2	-	x1	
M9001075	PS T 14/18 ≥ 4500 + screws / Schrauben / Visserie	x1	x2	x1	-	x4	-	x1	
M9001072	PS T 14/18 < 4500	x1	x1	x1	-	x2	-	x1	
M9001073	PS T 14/18 ≥ 4500	x1	x1	x1	-	x4	-	x1	
Retailed kits	-	-	-	-	M9000746	-	M9000742		

SCANIA P - R - G

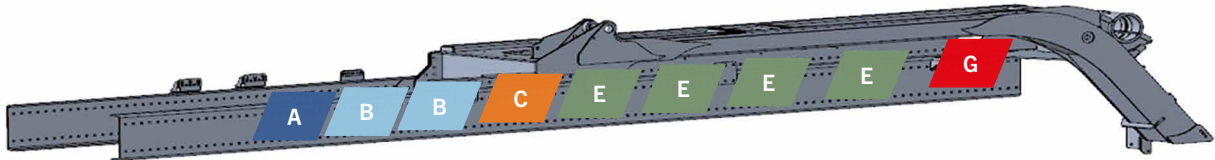

Diameter Durchmesser Diamètre (mm)	Length / Länge / Longueur (mm)					Nuts Nüsse Ecrus
	40	50	60	80	100	
Ø14	M9000464 (qty 50/box)	M9000465 (qty 50/box)	-	M9001032 (qty 25/box)	M9001033 (qty 25/box)	M9000463 qty (100/box)



PS T 14 - 18

		A	B	C	D	E	F	G	Bolts / Schrauben / Visserie
					-		-		
M9001070	PS T 14/18 < 4500 + screws / Schrauben / Visserie	x1	x2	x1	-	x3	-	x1	
M9001071	PS T 14/18 ≥ 4500 + screws / Schrauben / Visserie	x1	x2	x1	-	x4	-	x1	
M9001068	PS T 14/18 < 4500	x1	x2	x1	-	x3	-	x1	
M9001069	PS T 14/18 ≥ 4500	x1	x2	x1	-	x4	-	x1	
Retailed kits		-	-	-	-	M9000927	-	M9000752	

SKIPLOADER MOUNTING KIT

ABSETZKIPPER MONTAGEBAUSATZ

MULTIBENNE KIT FIXATION

DAF XD

DAF

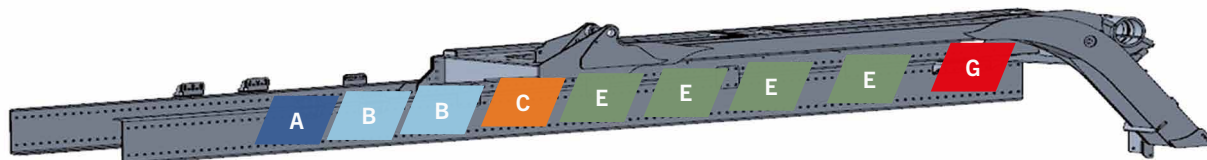

Diameter Durchmesser Diamètre (mm)	Length / Länge / Longueur (mm)					Nuts Nüsse Ecrans
	40	50	60	80	100	
Ø14	M9000464 (qty 50/box)	M9000465 (qty 50/box)	-	M9001032 (qty 25/box)	M9001033 (qty 25/box)	M9000463 qty (100/box)
Ø16	-	M9000505 (qty 50/box)	M9000506 (qty 50/box)	M9001128 (qty 25/box)	M9001129 (qty 25/box)	M9000507 (qty 100/box)

PST 14 - 18

	A	B	C	D	E	F	G	Bolts / Schrauben / Visserie
			-	-		-		

M9001078	PS T 14/18 < 4500 + screws / Schrauben / Visserie	x1	x1	-	-	x4	-	x1	
M9001079	PS T 14/18 ≥ 4500 + screws / Schrauben / Visserie	x1	x1	-	-	x6	-	x1	
M9001076	PS T 14/18 < 4500	x1	x1	-	-	x4	-	x1	
M9001077	PS T 14/18 ≥ 4500	x1	x1	-	-	x6	-	x1	
Retailed kits	-	-	-	-	M9000944	-	M9000332		

RETROFIT KITS

NACHRÜSTUNGSSÄTZE

KITS RÉTROFIT



General accessories
Allgemeines Zubehör
Accessoires généraux

Hookloader
Abrollkipper
Polybenne

Skiploader
Absetzkipper
Multibenne

Retrofit kits
Nachrüstungssätze
Kits rétrofit

RETROFIT KITS HOOKLOADER

NACHRÜSTUNGSSÄTZE ABROLLKIPPER

KITS RÉTROFIT BRAS

RAPID MOTION RETROFIT KIT FOR PHT / PH T eilgang nachrüstungssatz /
Kit rétrofit pour vitesse rapide PH T

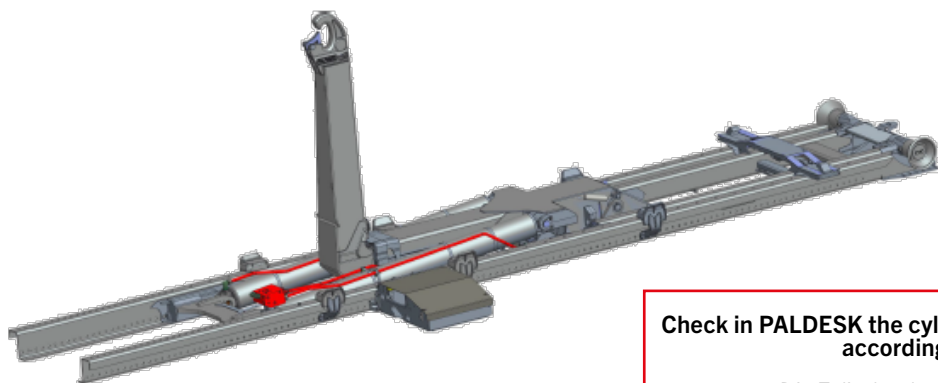

Check in PALDESK the cylinder dimension (Diameter and length) according to the equipment Nr

Die Zylinderabmessungen (Durch und Länge) nach Gerät-Nr in Paldesk prüfen

Vérifier dans PALDESK les dimensions (Diamètre et longueur) en accord avec le n° d'équipement.

PH T (A) (ACTS) (DINO) UNIT

	Kit size	XS	S	L
	Cylinder length	1715mm	1880mm	2035mm
Internal Cylinder Diameter <i>Zylinderinnendurchmesser</i> Diamètre intérieur vérin	Ø140mm	M9001152	M9001151	M9001148
	Ø150mm	M9001190	-	M9001146
	Ø160mm	-	M9001150	M9001147



ONLY AVAILABLE FOR SLD5 or TEC5

PH T (A) SCAN UNIT

	Kit size	S	L	XL
	Cylinder length	1880mm	2135mm	2350mm
Internal Cylinder Diameter <i>Zylinderinnendurchmesser</i> Diamètre intérieur vérin	Ø140mm	M9001182	M9001183	-
	Ø150mm	M9001184	M9001185	M9001186
	Ø160mm	M9001187	M9001188	M9001189



ONLY AVAILABLE FOR SLD5 or TEC5

ADD. FRONT LOCKING / Zusätzl. Hydraulische frontverriegelung/ Verr. avant additionnel

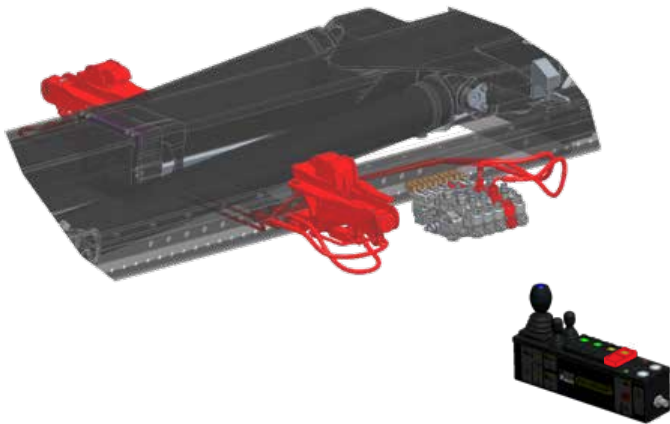

Contents:

Add. hydr. section / zusätzlicher Hydraulikabschnitt / Section hydr. additionnelle

Body - hooks and cylinders / Körper - Haken und Zylinder / Boitard - crochets et vérins

Hoses and pipes / Schläuche und Rohre / Flexibles et Tubes

Hydr. fittings / Hydraulischer Anschluss / Raccords hydr.

Electrical harness, sensors and rocker switch / Elektrischer Kabelbaum, Sensoren und Schalter / Faisceaux électriques, Capteurs et interrupteur

Application case Anwendungsfall Cas d'application	Part Nr Referenz Référence
PH T (A) Telescopic Power Synchron	M9000680



Order form available: Please contact your area sales manager

Bestellformular verfügbar: Bitte kontaktieren Sie ihren Vertriebsmitarbeiter

Bon de commande disponible: Contactez votre animateur réseau

**COMPLEMENTARY KIT FRONT LOCK. OPTION 3011 / komplementäres Kit Frontverriegelung
Option 3011 / Kit complémentaire verrouillage avant option 3011**

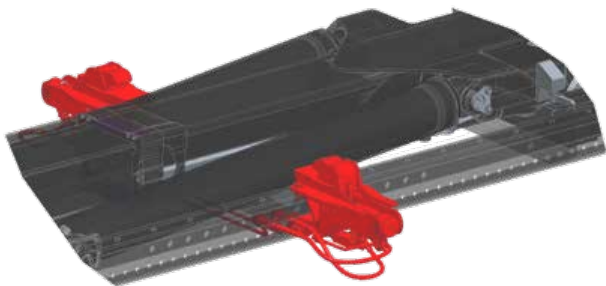

Contents:

Body - hooks and cylinders / Körper - Haken und Zylinder / Boitard - crochets et vérins

Pipes / Rohre / Tubes

Hydr. fittings / Hydraulischer Anschluss / Raccords hydr.

Sensors / Sensoren / Capteurs

Application case Anwendungsfall Cas d'application	Option code Optionscode Code option	Part Nr Referenz Référence
PH T 18 - 24		M9001204
PH T(A) DINO	3011	M9001205
PH T CHEM		M9001206

RETROFIT KITS HOOKLOADER

NACHRÜSTUNGSSÄTZE ABROLLKIPPER

KITS RÉTROFIT BRAS

CONTROL SYSTEM / *Steuersystem* / *Système de commande*

Designation <i>Bezeichnung</i> Désignation	Application case <i>Anwendungsfall</i> Cas d'application	Part Nr <i>Referenz</i> Référence	Views <i>Aussicht</i> Vues
--	--	---	----------------------------------

TEC 5 adaptation Kit for hooklift
TEC 5 Umbausatz für Abrollkipper
Kit adaptation TEC 5 pour bras

SLD5

M9001127



Radio adaptation Kit for hooklift SDS150
Funk Umbausatz für Abrollkipper SDS150
Kit adaptation radio pour bras SDS150

SLD5
TEC5

M9001199



Option 5202
or 5203

Radio adaptation Kit for hooklift SDS180
Funk Umbausatz für Abrollkipper SDS180
Kit adaptation radio pour bras SDS180

SLD5
TEC5

M9001200

PAD interface SDS 150
PAD Anschluss SDS 150
Interface PAD SDS 150

SLD5
TEC5

M9001284

NEW!

PAD interface SDS 180
PAD Anschluss SDS 180
Interface PAD SDS 180

SLD5
TEC5

M9001285

NEW!

Product Info 2022/07

External control

Epsilon HLC

Crane RRC

Asphalt app

Robotic lifting solution

Robotic lifting solution

Robotic lifting solution

Robotic lifting solution

Robotic lifting solution

Robotic lifting solution

Robotic lifting solution

Robotic lifting solution

Robotic lifting solution

Robotic lifting solution

Robotic lifting solution

Robotic lifting solution

Robotic lifting solution

Robotic lifting solution

Robotic lifting solution

Robotic lifting solution

Robotic lifting solution

Robotic lifting solution

Robotic lifting solution

Robotic lifting solution

Robotic lifting solution

Robotic lifting solution

Robotic lifting solution

Robotic lifting solution

Robotic lifting solution

Robotic lifting solution

Robotic lifting solution

Robotic lifting solution

Robotic lifting solution

Robotic lifting solution

Robotic lifting solution

Robotic lifting solution

Robotic lifting solution

Robotic lifting solution

Robotic lifting solution

Robotic lifting solution

Robotic lifting solution

Robotic lifting solution

Robotic lifting solution

Robotic lifting solution

Robotic lifting solution

Robotic lifting solution



Automatic mode actuation for PAD
Automatische Modusbetätigung für PAD
Activation du cycle automatique du PAD

SLD5
TEC5

M-PAD 8101

Service bulletin I-EH-1605



SLD Crane - Crane interface monitoring
SLD Kran - Kran Transportstellungs Schnittstelle
Grue SLD - Interface surveillance grue

TEC5

M9001203

NEW!

Product Info 2022/04

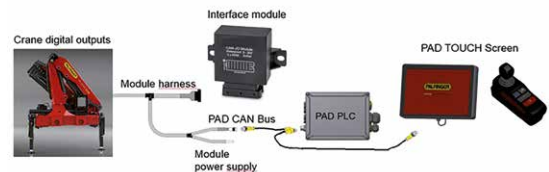

Detection kit of RRC emitter in charging base
Überwachungsatz für Funk Sender im Ladestation
Détection émetteur radio dans son chargeur

M9001377

NEW!



RETROFIT KITS SKIPLOADER

NACHRÜSTSÄTZE ABSETZKIPPER

KITS RÉTROFIT MULTIBENNE





THREADED LIFTING CHAINS / Beschichte Kettenaufhängung / Chaines de levage traitées

COROLIM®







Protection against corrosion min 400h
Korrosionsschutz min 400 Stunden
Protection anticorrosion mini 400h



NEW!

	Designation <i>Bezeichnung</i> Désignation	Link Ø [mm] <i>Glied</i> Maillon	Unit capacity [t] <i>Hubkapazität</i> Capacité levage	Reference <i>Teil Nummer</i> Référence	Option code <i>Optionscode</i> Code option	Features <i>Eigenschaften</i> Caractéristiques
	Lifting chain with self-locking hook <i>Kettenaufhängung mit selbstverriegelnde Haken</i> <i>Chaîne de levage à crochet auto verrouillé</i>	13	8 - 14	M3021068 NEW!	9625 (TEC3)	
		16	16 - 18	M3021076	9625 (TEC3)	
	Lifting chain with skip suspension and safety latch <i>Kettenaufhängung mit Einhandbedienung und Hakensicherheit</i> <i>Chaîne de levage avec anneau et linguet de sécurité</i>	13	8 - 14	M3021781 NEW!	9610 (TEC3)	
		16	16 - 18	M3021074	9610 (TEC3)	
	Secured chain shortener <i>Kettenverkürzer mit Sicherheit</i> <i>Raccourcisseur de chaîne avec sécurité</i>	13	8 - 14	M3021073 NEW!	9630 (TEC3)	
		16	16 - 18	M3021078	9630 (TEC3)	

LIFTING CHAINS / Kettenaufhängung / Chaines de levage

	Designation <i>Bezeichnung</i> Désignation	Link Ø [mm] <i>Glied</i> Maillon	Unit capacity [t] <i>Hubkapazität</i> Capacité levage	Reference <i>Teil Nummer</i> Référence	Option code <i>Optionscode</i> Code option	Features <i>Eigenschaften</i> Caractéristiques
	Lifting chain with self-locking hook <i>Kettenaufhängung mit selbstverriegelnde Haken</i> <i>Chaîne de levage à crochet auto verrouillé</i>	13	8 - 14	M3008885	9625 (SLD)	
		16	16 - 18	M3009536	9625 (SLD)	
	Lifting chain with skip suspension and safety latch <i>Kettenaufhängung mit Einhandbedienung und Hakensicherheit</i> <i>Chaîne de levage avec anneau et linguet de sécurité</i>	13	8 - 14	M3004966	9610 (SLD)	
		16	16 - 18	M3006590	9610 (SLD)	
	Chain shortener <i>Kettenverkürzer</i> <i>Raccourcisseur de chaîne</i>	13	8 - 14	M3004965	9607 (SLD)	
		16	16 - 18	M3002422	9607 (SLD)	
	Secured chain shortener <i>Kettenverkürzer mit Sicherheit</i> <i>Raccourcisseur de chaîne avec sécurité</i>	13	8 - 14	M3009403	9630 (SLD)	
		16	16 - 18	M3009404	9630 (SLD)	

General accessories
Allgemeines Zubehör
Accessoires généraux

Hookloader
Abrollkipper
Polybenne

Skiploader
Absetzkipper
Multibenne

Retrofit kits
Nachrüstungssätze
Kits rétrofit

RETROFIT KITS SKIPLoader

NACHRÜSTUNGSSÄTZE ABSETZKIPPER

KITS RÉTROFIT MULTIBENNE





TIPPING CHAIN / Kippkette / Chaîne de bennage

Designation / Bezeichnung / Désignation	Ø [mm]	Capacity [t] Kapazität capacité	Reference Referenz Référence	Option code Optionscode Code option
 <p>Tipping chain Kippkette Chaîne de bennage</p>	-	All Alle Tous	M3002392	9616/9604

PULLING CHAIN / Ziehkette / Chaîne de traction

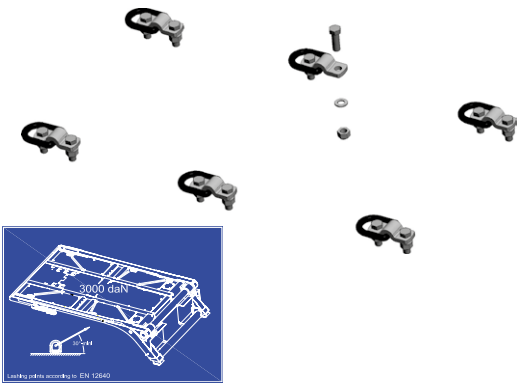
Designation / Bezeichnung / Désignation	Ø [mm]	Capacity [t] Kapazität capacité	Reference Referenz Référence	Option code Optionscode Code option
 <p>Pulling chain with support Ziehkette mit Halter Chaîne de traction avec support</p>	13	All Alle Tous	M2150776 NEW!	9608

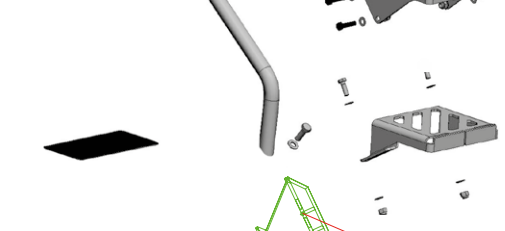
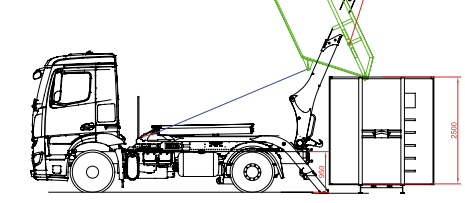
MISCELLANEOUS/ Sonstiges / Divers

	Designation Bezeichnung Désignation	Reference Referenz Référence	kg	Option code Optionscode Code option
 <p>6 Lashing rings kit + sticker Bausatz 6 Zurrösen + Sticker Kit 6 anneaux d'arrimage + autocollant</p>		M9001036	11	9632
 <p>Rear access Right kit Bausatz Heckzugang rechts Kit d'accessibilité Arrière droit</p>		M2150633	6	9634
 <p>Rear access Left kit Bausatz Heckzugang links Kit d'accessibilité Arrière gauche</p>		M2150632	6	9633
 <p>High tipping only for TEC3 Hochentleerung nur TEC3 Bennage en hauteur seulement pour TEC3</p>		M2150771 NEW!	-	PS T TEC 9623
 <p>RRC Kit for PST SLD5 Funk Umbausatz für PST SLD5 Kit radio pour PST SLD5</p>		M9001201	-	5033
 <p>Magnet fixing for radio emitter Magnetbefestigung für Funk Sender Fixation aimant pour émetteur radio</p>		M65031319 NEW!	-	-

General accessories
Allgemeines Zubehör
Accessoires généraux

Hookloader
Abrollkipper
Polybenne

Skiploader
Absetzkipper
Multibenne

Retrofit kits
Nachrüstungsätze
Kits rétrofit

GPA-MOUNTING INSTRUCTIONS

GPA-MONTAGEANLEITUNG

GPA-INSTRUCTIONS DE MONTAGE



Mounting Instructions available in Palfinger Extranet / Die Montageanleitungen sind im Palfinger Extranet verfügbar / Instructions de montage disponibles dans Palfinger Extranet: [PALDESK/Products/Service/Hooklift Europe/Installation guidelines](#)



Mounting Instructions available in Palfinger Extranet / Die Montageanleitungen sind im Palfinger Extranet verfügbar / Instructions de montage disponibles dans Palfinger Extranet: [PALDESK/Products/Service/Hooklift Europe/Installation guidelines / Truck Manufacturer Requirements](#)

GUIMA PALFINGER SAS

29 A, Avenue des Tourondes - BP 49
82303 CAUSSADE - FRANCE



KP-MOUNTINGHOOKM4 07/2023

Units shown in the leaflet are partially optional equipped and do not always correspond to the standard version. Country-specific regulations must be observed. Dimensions may vary. Subject to technical changes, errors and translation mistakes.

Die abgebildeten Geräte sind teilweise mit Wunschausrüstung ausgestattet und entsprechen nicht immer der Standardausführung. Beim Geräteaufbau sind länderspezifische Vorschriften zu beachten. Maßangaben unverbindlich. Technische Änderungen, Irrtümer und Übersetzungsfehler vorbehalten.

Certains équipements en photos dans ce document sont dotés d'options et ne correspondent pas au modèle standard. Des réglementations nationales spécifiques relatives à la configuration sont à observer. Les dimensions ne revêtent pas un caractère contraignant. Sous réserve de modifications techniques, d'omissions et d'erreurs de traduction.