

PALFINGER

P 570

FLEXIBILITY AT FULL HEIGHT

LIFETIME EXCELLENCE



HIGHLIGHTS

- Telescopic upper boom up to 19 m
- Automatic telescope lubrication system supplies the lower boom telescopes with grease during platform operation
- 900 mm stabilising stroke to compensate for highly uneven terrain
- Telescopic basket with 600 kg basket load and integrated preparation for Powerlift system
- Hanging basket enables users to get close to objects

STANDARDS













- Reverse camera
- Home function
- Automated positioning system
- Telescopic cage
- Driver information system
- Safety plates
- 230 V CEE current supply with CEE socket in the workman cage
- Assistance systems

OPTIONS

- Light packages
- Workman basket collision protection thanks to ultrasonic sensors
- Telescopic camera basket with 600 kg basket load
- Attachable cable winch under the workman basket with 460 kg lifting capacity
- Mobile radio remote controls for access platform and stabiliser operation



TECHNICAL SPECIFICATIONS

	Total weight *	26000 kg		max. outreach	41 m
	Overall length	11.93 m		Rotation angle of turntable	540°
	Width in transportposition	2.51 m		Rotation angle of cage	2 x 200°
	Height in transportposition	3.90 m		Rotation angle of cage boom	240°
	max. stabiliser width	8.89 m		Size of cage	3.81 x 1.04 x 1.10 m
	max. working height	57 m		max. cage load	600 kg
	max. cage bottom height	55 m			

* Depends on truck chassis

WORKING DIAGRAMS

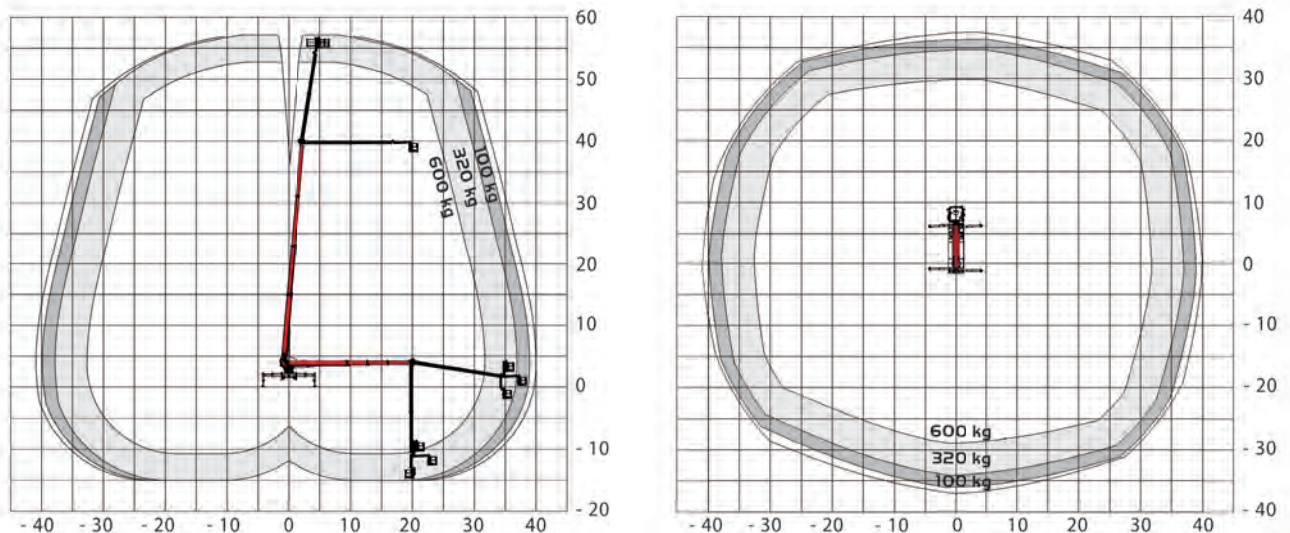

A possible 2% tolerance is contingent on structural components

DIMENSIONS

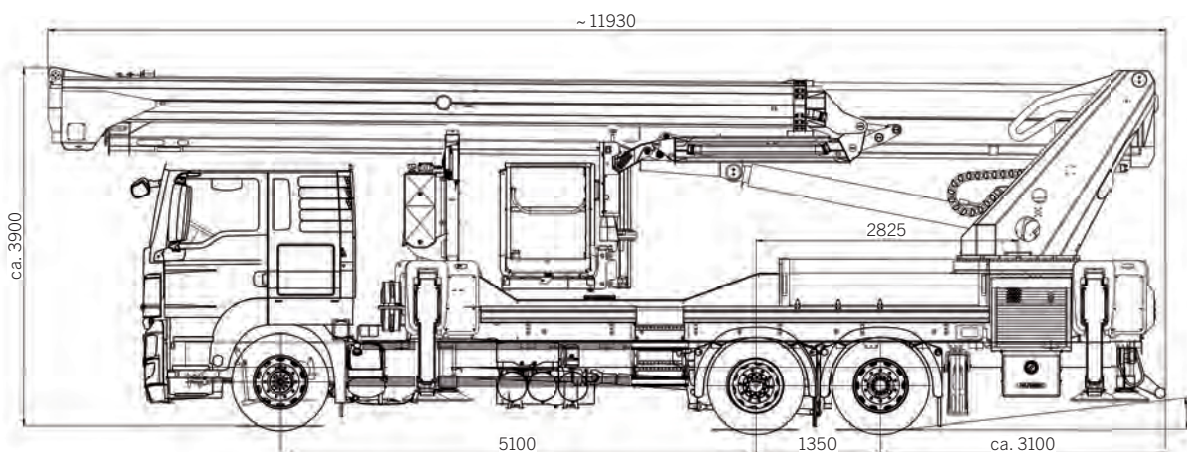

YOUR CONTACT

Palfinger Platforms GmbH

Düsseldorfer Str. 100
47809 Krefeld | Germany

KP-P570M2+EN

Units shown in the leaflet are partially optional equipped and do not always correspond to the standard version. Country-specific regulations must be observed. Dimensions may vary. Subject to technical changes, errors and translation mistakes.