

PALFINGER

P 300 KS FACELIFT

**COMFORT LIKE
NEVER BEFORE**

LIFETIME EXCELLENCE



HIGHLIGHTS

- 30m working height with 400kg cage load
- Powerlift-System with max. 300kg payload, 150kg per load cross beam/boom
- Improved performance data of minimal mode: 10° movement to the left and right with full jib manoeuvrability, operations at 8 meters working height without stabilizers
- Improvement of ergonomics: optimized underrun protection due to enlarged control boxes as well as improved slope angle
- Stabilizer operation from the base at the left and at the right side
- Convenient access to the working cage
- Thanks to the fully variable stabilizer system, the stabilizers can be positioned precisely, even on uneven terrain with 730mm stroke and up to 5° of inclination
- The shortest overall length and wheelbase in this class (3050mm) ensures good manoeuvrability

STANDARDS













- Home function
- Memory function
- Foldable Aluminium bordering enable easy transport of bulky parts
- Cage load measurement device
- Cage exchange system - enables an easy and quick exchange of aluminium and fiberglass working cages
- Automatic adjustment of outreach due to monitoring of the platform's inclination. Fast, safe working despite vehicle inclination.
- 4 Safety spreader plates
- Battery voltage monitor
- Emergency control panel
- 230V CEE power supply with CEE socket in the workman cage

OPTIONS

- Protection guard on top of driver's cab
- Dividing screen with bracket at the main boom rest and in the cage
- Wooden frame on the cage
- Bracket for chainsaw
- Bracket for 7 traffic cones mounted on the chassis covering
- Airline rails at the bordering incl. 4 fittings
- Vertical parallel drive of the cage
- 2 covers for warning beacons at the turntable and at the main boom rest
- 4 working lights mounted at the basic frame to illuminate the outrigger areas
- 2 working lights mounted on the left and right side at the main boom rest to illuminate the surrounding
- Short rear underrun protection (with integrated rear lighting)
- Electric emergency pump
- Device for checking axle-position for both axles, with one sensor per tyre each
- Insulation package in combination with aluminium cage: Double insulation against 1000V according to DIN VDE 0682-742.
- Possibility of mounting on all-wheel drive or standard chassis of various manufacturers and weight classes with optimized jack-up widths



TECHNICAL SPEZIFICATIONS

	Total weight*	7490 kg		max. outreach *	20,50 m
	Overall length	7,60 m		Rotation angle of turntable	540°
	Width in transportposition	2,52 m		Rotation angle of cage	+/-85°
	Height in transportposition	3,50 m		Rotation angle of cage boom	195°
	max. stabiliser width	5,00 m		Size of cage	1,80 x 1,0 x 1,10 m
	max. working height	30 m		max. cage load	400 kg
	max. cage bottom height	28 m			

* Depends on truck chassis

WORKING DIAGRAMS

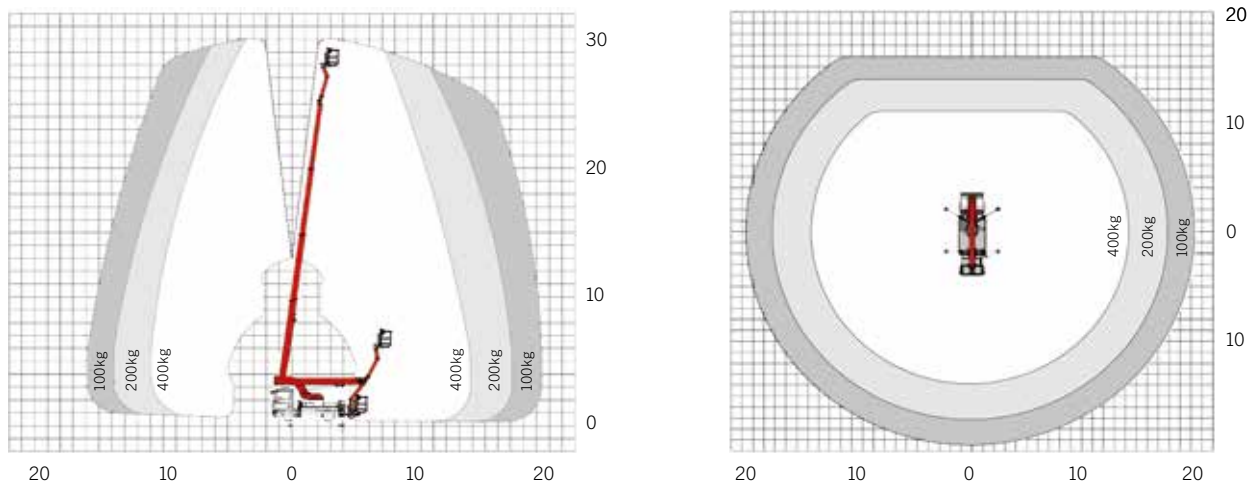

A possible 2% tolerance is contingent on structural components

DIMENSIONS

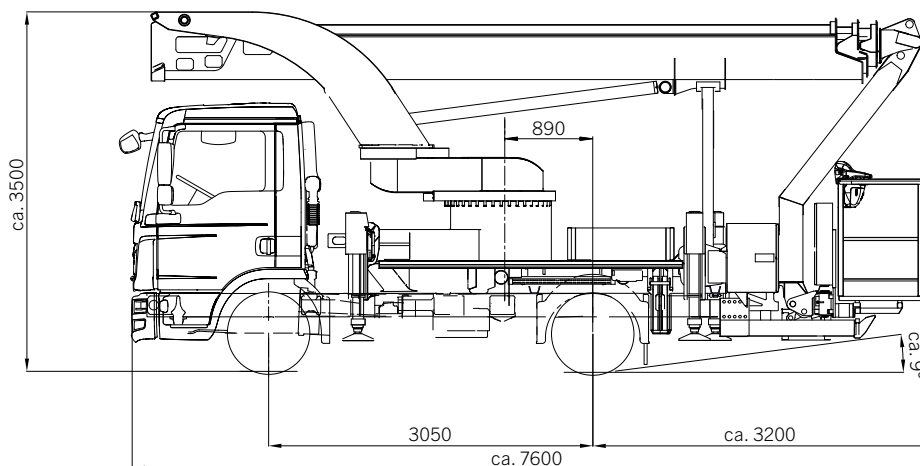

YOUR CONTACT

Palfinger Platforms GmbH

Düsseldorfer Str. 100
47809 Krefeld | Germany

KP-P300 KSM3 +EN

Units shown in the leaflet are partially optional equipped and do not always correspond to the standard version. Country-specific regulations must be observed. Dimensions may vary. Subject to technical changes, errors and translation mistakes.