

PALFINGER

P 220 BK

AGILE AND COMPACT

LIFETIME EXCELLENCE

PALFINGER P 220 BK

HIGHLIGHTS

- Stabiliser operation from the base for easy and safe support
- Robust aluminium workman basket with 300 kg cage load and integrated anti-squeeze protection function in the knee rail
- Automatic support stabilising with wheel clearance monitoring
- Flat substructure under the workman basket allows users to get as close to obstacles as possible
- Full range with vertical support on large chassis (7.5t)

STANDARDS













- Home function
- Automated positioning system
- Safety plates
- 230V CEE current supply with CEE socket in the workman basket
- European type approval
- Stabiliser control at basis

OPTIONS

- Tree maintenance package (tree basket, wooden edge, protective roof, chainsaw mount)
- Protective grating above cab
- Display at the base, including height limitation
- Display in the workman basket, including adjustment of ramps
- Aluminium edging
- Dual insulation with plastic basket



TECHNICAL SPECIFICATIONS

	Total weight *	3330 kg		max. outreach	16.90 m
	Overall length	7.40 m		Rotation angle of turntable	500°
	Width in transport position	2.22 m		Rotation angle of cage	2 x 90°
	Height in transport position	2.99 m		Rotation angle of cage boom	185°
	max. stabiliser width	3.60 m		Size of cage	1.40 x 0.70 x 1.10 m
	max. working height	22 m		max. cage load	300 kg
	max. cage bottom height	20 m			

* Depends on truck chassis

WORKING DIAGRAMS

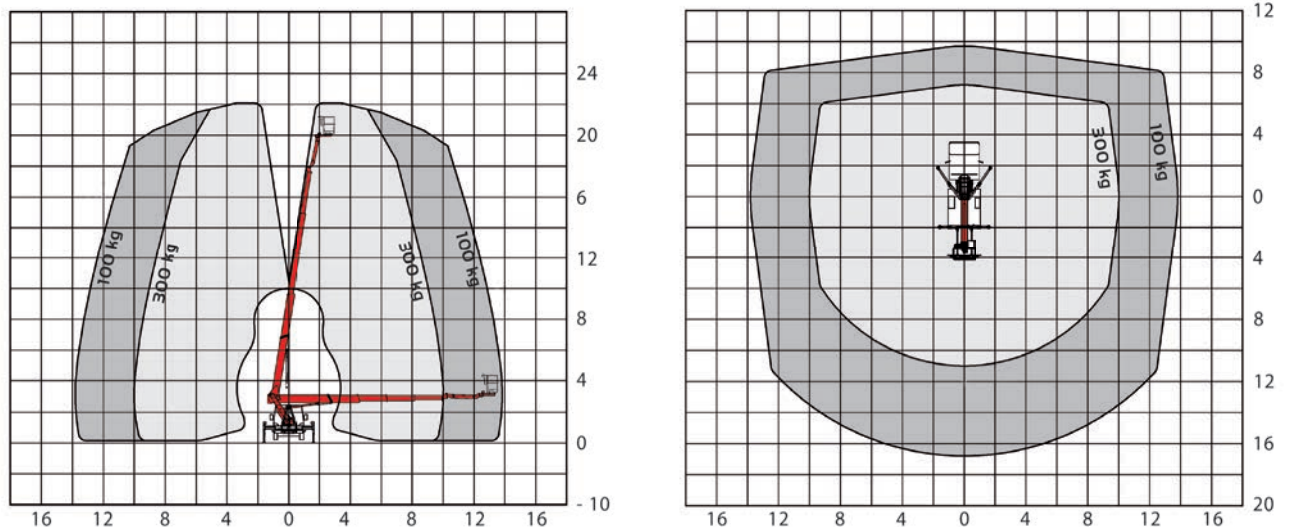

A possible 2% tolerance is contingent on structural component

DIMENSIONS

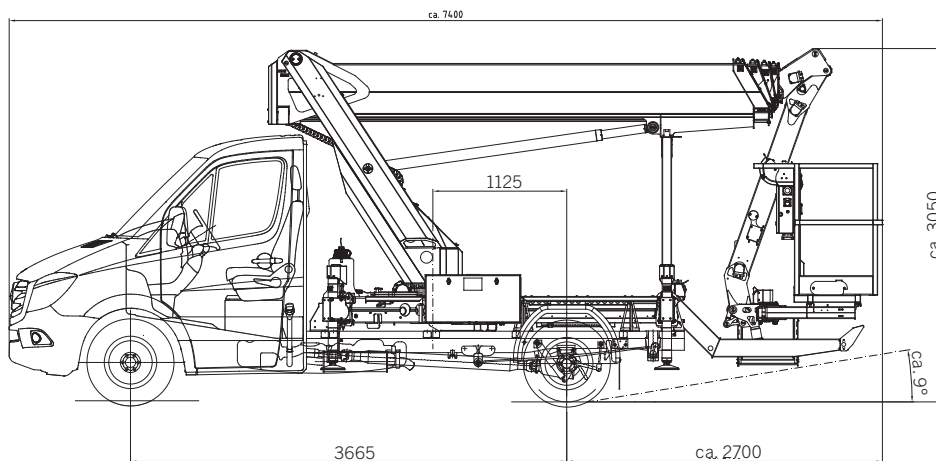

YOUR CONTACT

Palfinger Platforms GmbH
Düsseldorfer Str. 100
47809 Krefeld | Germany

KP-P220BKM1+EN

Units shown in the leaflet are partially optional equipped and do not always correspond to the standard version. Country-specific regulations must be observed. Dimensions may vary. Subject to technical changes, errors and translation mistakes.