

PALFINGER

P 180 BK

SMALL AND COMPACT

LIFETIME EXCELLENCE



HIGHLIGHTS

- Stabiliser operation from the base for easy and safe support
- Robust aluminium workman basket with 300 kg basket load and integrated anti-squeeze protection function in the knee rail
- Automatic support stabilising with wheel clearance monitoring
- Flat substructure under the workman basket allows users to get as close to obstacles as possible
- Can be mounted on various chassis (3.5 t - 7.5 t)

STANDARDS













- Home function
- Automated positioning system
- Safety plates
- 230V CEE current supply with CEE socket in the workman basket
- European type approval
- Stabilizer control at basis and in cage

OPTIONS

- Tree maintenance package (tree basket, wooden edge, protective roof, chainsaw mount)
- Display at the base, including height limiting
- Display in the workman basket, including adjustment of ramps
- Aluminium edging
- Dual insulation with plastic cage



TECHNICAL SPECIFICATIONS

	Total weight (kg)*	3330 kg		max. outreach	13.0 m
	Overall length	7.40 m		Rotation angle of turntable	500°
	Width in transportposition	2.22 m		Rotation angle of cage	2x 90°
	Height in transportposition	3.05 m		Rotation angle of cage boom	185°
	max. stabiliser width	3.60 m		Size of cage	1.40 x 0.70 x 1.10 m
	max. working height	17.6 m		max. cage load	300 kg
	max. cage bottom height	15.6 m			

* Depends on truck chassis

WORKING DIAGRAMS

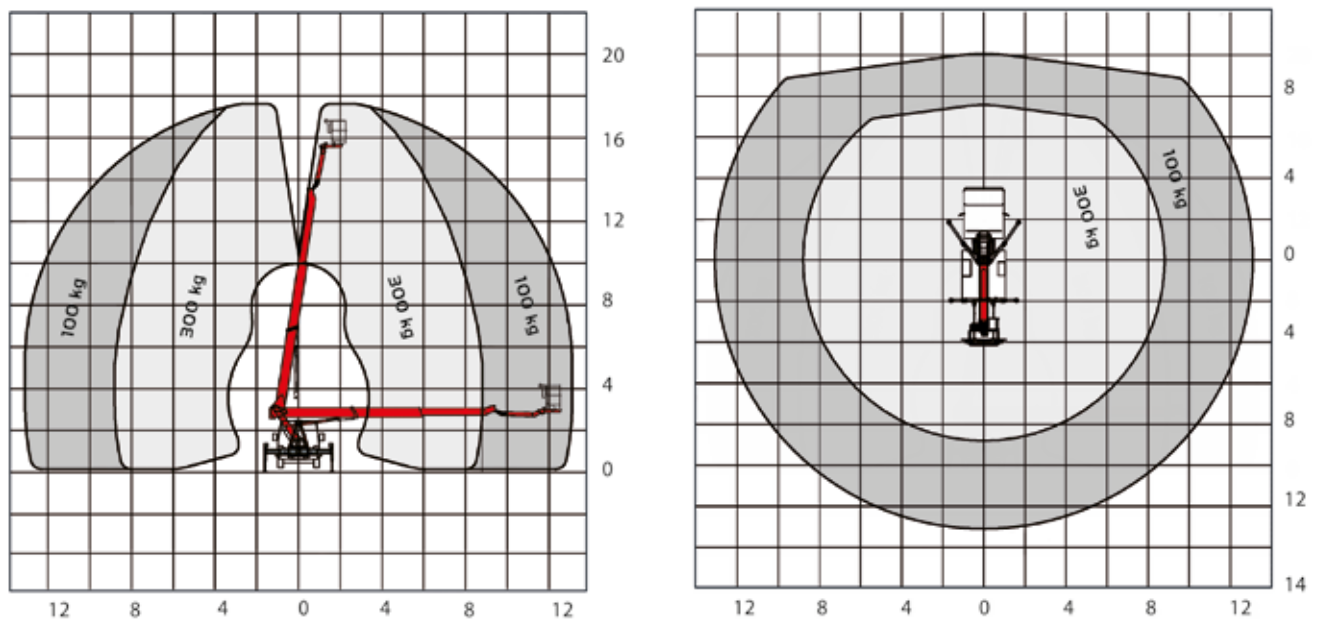

A possible 2% tolerance is contingent on structural components

DIMENSIONS

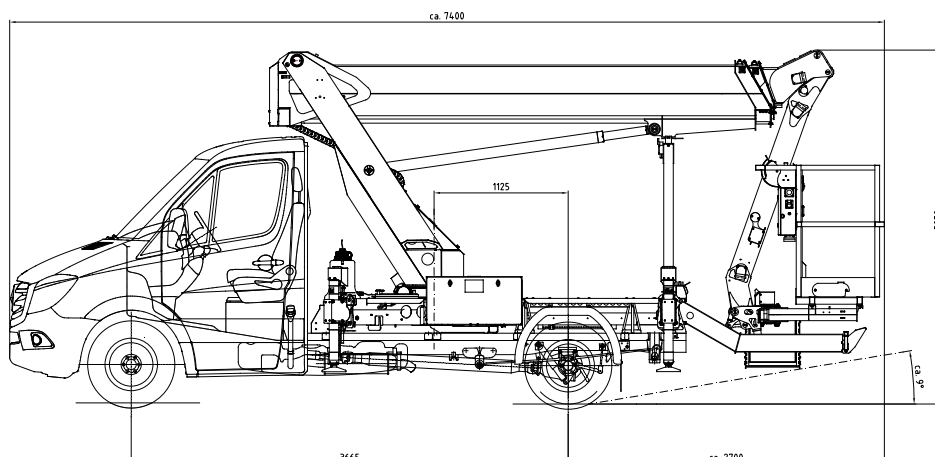

YOUR CONTACT

Palfinger Platforms GmbH
Düsseldorfer Str. 100
47809 Krefeld | Germany

KP-P180BKM1+EN

Units shown in the leaflet are partially optional equipped and do not always correspond to the standard version. Country-specific regulations must be observed. Dimensions may vary. Subject to technical changes, errors and translation mistakes.