

D51EXi/PXi-24



Crawler dozer



Engine power
99.0 kW/133 HP @ 2200 rpm

Operating weight
D51EXi-24: 13820 kg
D51PXi-24: 14300 kg

Blade capacity
D51EXi-24: 2.7 - 2.9 m³
D51PXi-24: 2.9 - 3.35 m³

Increase your productivity by 100% with
next-generation intelligence



Engine power
99.0 kW/133 HP @ 2200 rpm

Operating weight
D51EXi-24: 13820 kg
D51PXi-24: 14300 kg

Blade capacity
D51EXi-24: 2.7 - 2.9 m³
D51PXi-24: 2.9 - 3.35 m³

Intelligent Machine Control 2.0

- Automated operation from rough dozing to finish grade
- Lift layer control
- Tilt steering control
- Quick surface creation
- Using multiple GNSS systems
- Integrated & standard factory installed

Powerful and environmentally friendly

- Low consumption EU Stage V engine
- Optimised Hydrostatic Transmission (HST) control system
- Adjustable auto idle shutdown
- Hydrostatic cooling fan with cleaning mode

First-class comfort

- Unique super-slant nose design
- Quiet and comfortable cab
- Fully adjustable air-suspended seat
- Integrated rear-view camera

Optimised work equipment

- INPAT blade with adjustable pitch
- Multishank parallelogram ripper



State-of-the-art controls

- Extremely manoeuvrable hydrostatic drive
- Variable speed selection or conventional quick shift
- Palm Command Control System (PCCS)
- Large multifunctional monitor with troubleshooting function

Tough and reliable

- Low-drive 'PLUS' undercarriage
- Sturdy, rugged design
- Self-adjusting idler support
- Rear-mount radiator with swing-up hydraulic fan
- Full LED lighting

Komtrax

- Komatsu Wireless Monitoring System
- 4G mobile communications
- Integrated communication antenna
- Increased operational data and reports



A maintenance program for Komatsu customers

Intelligent Machine Control 2.0



Intelligent Machine Control (iMC) 2.0

With the D51EXi/PXi-24, you benefit from second-generation intelligent Machine Control (iMC 2.0). It continuously scans the jobsite and uses the data to plan the next pass. This leads to a huge increase in your productivity and accuracy with just the press of a button. The D51EXi/PXi-24 can work in automation modes almost continuously, is furnished with ergonomic one-touch controls, and allows any operator to work like a pro.



Quick surface creation

You can create a temporary design surface by just pressing a button. Begin stripping or spreading in automatic modes without needing final design data.



Tilt steering control

Helps you to maintain straight travel by continuously and automatically tilting the blade. This gives you a cleaner cut and higher productivity. Compared to a machine without tilt steering control, operator input is reduced by up to 80%.

Lift layer control

This function measures the terrain your machine tracks over and uses that data to plan the next pass. Automatic blade control will follow the finish surface and eliminate excess fill, potentially doubling your production.

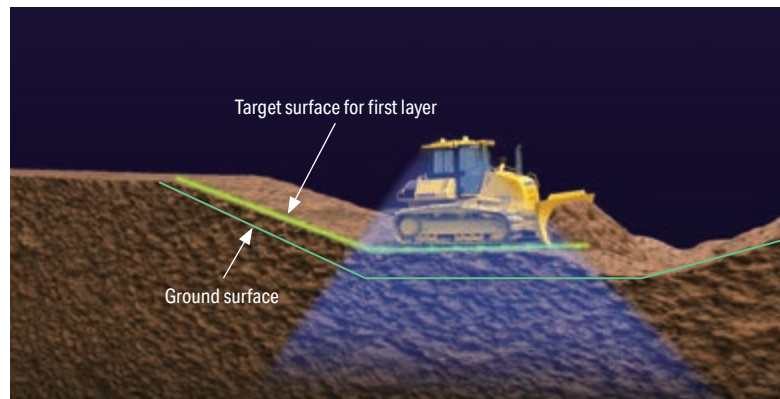

Proactive dozing control

You can use automatic blade control from rough grading to finish grading work. Proactive dozing control understands the terrain in the path of each cut, maximises the blade load throughout the pass, regardless of the terrain ahead, and helps to achieve the same productivity as from an experienced operator.

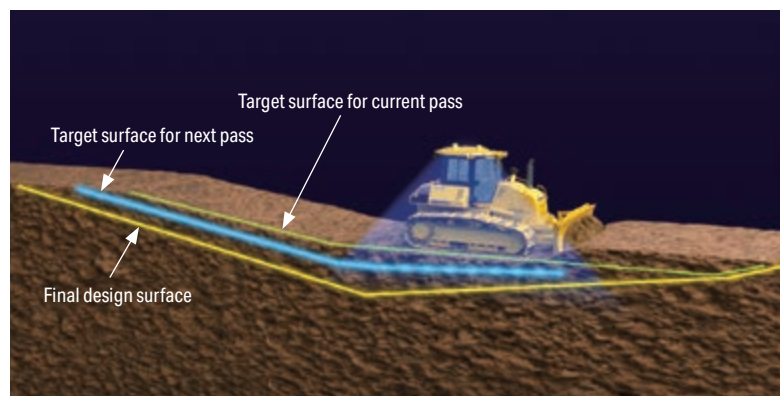

Factory integrated

All components for machine control are installed during assembly at the Komatsu manufacturing facility, ensuring a reliable and high quality installation. Komatsu customer support is extended to the machine control system itself.

Two roof-mounted multi-GNSS antennas

Reliability is improved by two antennas supporting multiple GNSS systems: GPS, GLONASS, Galileo, BeiDou and QZSS. Excellent blade accuracy is maintained even when working on slopes or under shadows from obstructions.

Standard touchscreen control box

Factory-installed, it features a simple, easy-to-use operator interface. Mounted high for excellent visibility, viewing angle is adjustable per operator preference. It comes installed with a choice of 25 European languages.

Benefits of iMC 2.0



Proactive dozing control

- Up to 60% more productive*
- Applications: stripping topsoil, high-production dozing
- Uses data from previous pass to plan the next pass
- Automatic cut/strip from existing terrain
- Helps new operators perform like an experienced one



Lift layer control

- Lift time reduced by up to 50%**
- Applications: lifting, compaction quality control
- Maintain precise lift thickness
- Automatically spreads lift from existing terrain and helps prevent overfill
- Up to double the production



Tilt steering control

- Up to 80% less operator input required**
- Automatically tilts the blade to maintain straight travel while rough dozing
- Maintains consistent power to the ground and track



Improved finish grading

- Over-cutting (cutting too deep) reduced by up to 50%*
- Applications: Finish grading
- Analyses terrain and 3D model to proactively position blade in hard-to-grade areas
- Helps prevent overcutting at finish grade

Use automation throughout the entire process

Bidding

1. Stripping topsoil

2. Mass excavation

3. Finish grading

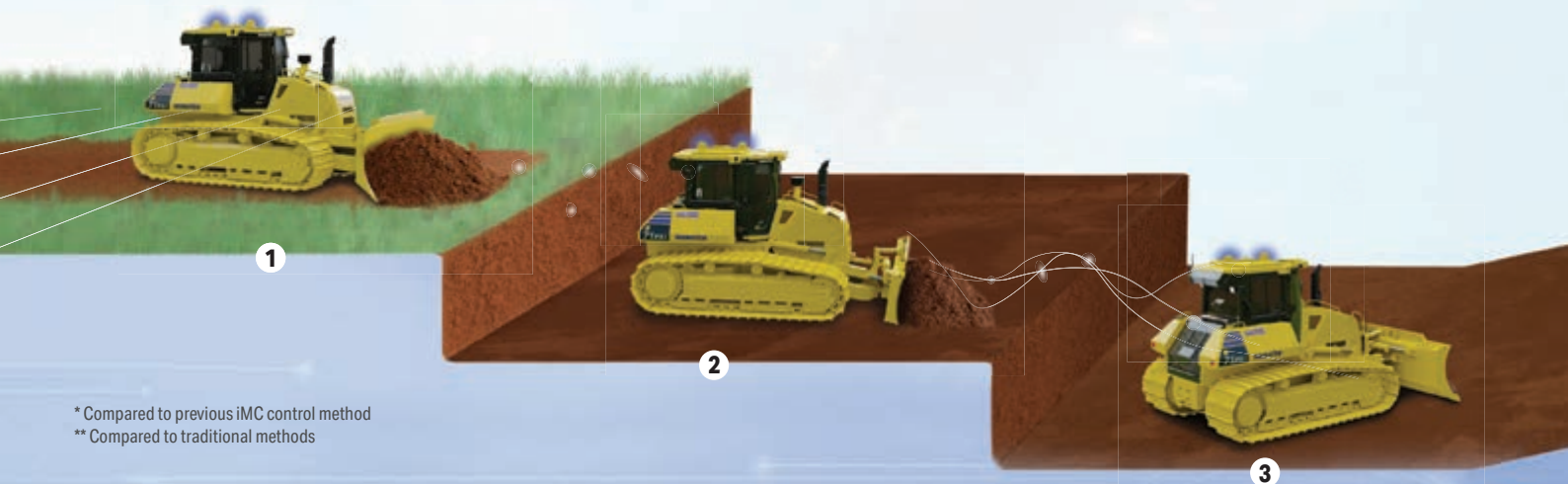

* Compared to previous iMC control method
** Compared to traditional methods



SMART CONSTRUCTION Remote

Smart Construction Remote is an optional software solution that enables to remotely send and update design plans even when the machine is offline. It also supports your operators remotely with shared screen control. Does an operator have an issue? Spare yourself that trip to the machine and resolve the problem from home, your office, or another jobsite. Smart Construction Remote works on our very own Komatsu iMC machines and several After Market GNSS systems powered by Windows and Android.

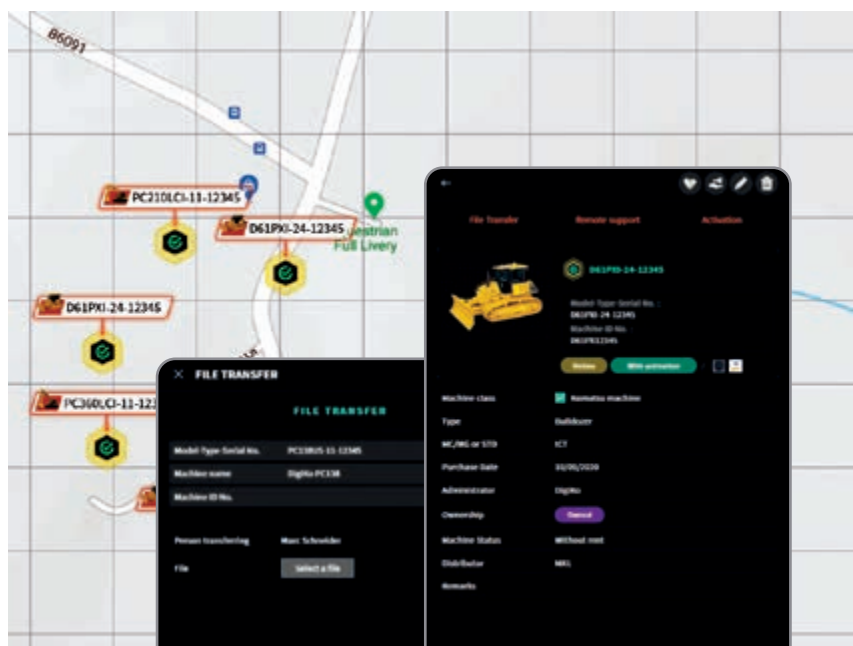

For further information on Smart Construction Remote please check out smartconstruction.io



Highly efficient hydrostatic drive line

The hydrostatic drive line is a key factor in the performance of the D51EXi/PXi-24 dozer. It supplies high drawbar pull when needed and a highly fuel efficient drive line for grading and precision work. With a choice between two operating modes, the operator can select either 'quick shift' or 'variable speed' to match a complete range of applications in the most economic and easy way.

Hydrostatic transmission (HST) control system

The unique, Komatsu-designed hydrostatic transmission controller monitors the engine output and working equipment or travel load. It controls the HST pumps' and motors' displacement to deliver optimum speed and drawbar pull. In addition, the controller provides ample power to both tracks when turning, enabling counter-rotation at very low speeds and making the D51EXi/PXi-24 extremely manoeuvrable.

Efficient hydrostatic engine cooling fan

The cooling fan always runs at the lowest convenient speed. Rotation and velocity are electronically adjusted based on the temperature of the engine coolant and hydraulic oil. This reduces fuel consumption and operating noise levels, and requires less horsepower than a belt-driven fan. For extra efficiency, the fan also has a large air outlet surface.

Powerful and environmentally friendly

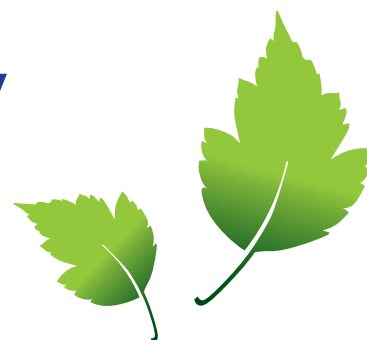

Komatsu EU Stage V

The Komatsu EU Stage V engine is productive, dependable and efficient. With ultra-low emissions, it provides a lower environmental impact and a superior performance to help reduce operating costs and lets the operator work in complete peace of mind.

Heavy-duty aftertreatment

The aftertreatment system combines a Komatsu Diesel Particulate Filter (KDPF) and Selective Catalytic Reduction (SCR). The SCR injects the correct amount of AdBlue® into the system at the proper rate to break down NOx into water (H₂O) and non-toxic nitrogen gas (N₂).

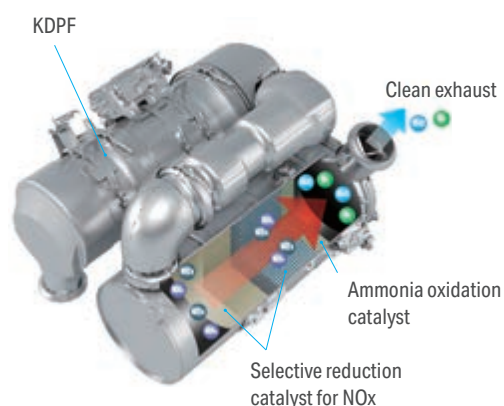

High-Pressure Common Rail (HPCR)

To achieve complete fuel burn and lower exhaust emissions, the heavy-duty High-Pressure Common Rail fuel injection system is computer controlled to deliver a precise quantity of pressurised fuel into the redesigned engine combustion chamber by multiple injections.



Adjustable idle shutdown automatically turns off the engine after it idles for a set period of time



Eco-gauge, Eco guidance and fuel consumption gauge

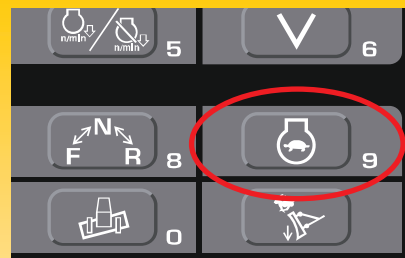

The new auto-deceleration function automatically lowers engine speed, when levers are in neutral for a set time

First-class comfort



Quiet and comfortable cab

Operator comfort is essential for safe and productive work. The cab on the D51EXi/PXi-24 is quiet and comfortable, an ideal environment to concentrate on the job. Its hexagonal design and large tinted glass windows offer excellent panoramic visibility. The high capacity climate control system pressurises the cab to keep dust out. A high quality sound-absorbent lining covers the interior to minimise noise levels for the operator. The operator can connect his mobile device to the machine's Bluetooth® radio.

The best view

A super slant nose gives the D51EXi/PXi-24 the best visibility of any dozers on the market. This unique feature dramatically increases efficiency and jobsite safety, with operators now always having full view of both the blade and the ripper and of objects close to them. The new cab-forward design, with integrated ROPS/FOPS and large glass windows, provides more room and places the operator closer to the blade, further improving visibility and comfort. Standard LED lighting further improves visibility around the machine in low light conditions.

Fully-adjustable, heated air-suspended seat

The driver's seat and console are amongst the most important components of the driver's equipment. The comfortable, heavy-duty, air-suspended seat, complete with headrest, gives the operator a secure and comfortable work environment.

Control features

Large TFT colour multifunctional monitor

A large user-friendly colour monitor enables safe, accurate and smooth work. It provides on-hand data to continuously improve productivity and fuel consumption. Multilingual and with all essential information available at a glance, it features simple and easy to operate switches and multifunction keys that provide the operator with fingertip access to a wide range of functions and operating information.

Automatic speed change

Komatsu HST controller always changes the travel speed automatically, depending on load or ground conditions, and efficient operations are facilitated – with no shift shocks. The dozer can work at the optimal speed and drawbar pull point, increasing productivity and fuel efficiency.

Easy operation control

The ergonomic Palm Command Control System (PCCS) provides efficient and comfortable steering of the machine. The blade's electronic control joystick provides precise control. Its reactivity can be customised to the operator's preference, for maximum productivity in any type of application.



Palm Command Control System (PCCS)

Selectable working modes

Working mode can be set to either 'Power' for maximum power or to 'Economy' for energy saving operations. Combined with a choice between automatic or manual working mode, this lets the operator select the optimum machine power configuration for the work at hand.



Combined decelerator/brake pedal





An evolutionary interface

Helpful information is now easier than ever to find and understand with the upgraded monitor interface. An optimal main screen for the ongoing work can be selected simply by pressing the F3 key.

Lower operating costs

Komatsu ICT contributes to the reduction of operating costs by assisting to comfortably and efficiently manage operations. It raises the level of customer satisfaction and the competitive edge of our products.

Widescreen monitor

Installed with a choice of 26 languages, the widescreen monitor with simple switches and multifunction keys gives fingertip access to a large range of functions and operating info.



Quick view on the operation logs



All information at a glance

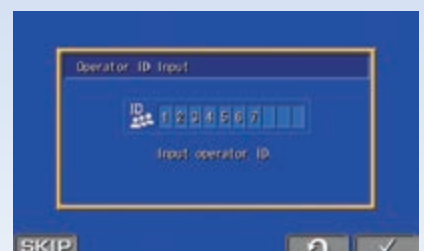

Operator identification function

Information & communication technology (ICT)



Knowledge

You get quick answers to basic and critical questions about your machines – what they're doing, when they did it, where they're located, how they can be used more efficiently and when they need to be serviced. Performance data is relayed by wireless communication technology (satellite, GPRS or 4G depending on model) from the machine to a computer and to the local Komatsu distributor – who's readily available for expert analysis and feedback.

Convenience

Komtrax enables convenient fleet management on the web, wherever you are. Data is analysed and packaged specifically for effortless and intuitive viewing in maps, lists, graphs and charts. You can foresee eventual maintenance issues and required spare parts, and troubleshoot a problem before Komatsu technicians arrive on site.



The way to higher productivity

Komtrax uses the latest wireless monitoring technology. Compatible on PC, smartphone or tablet, it delivers insightful and cost saving information about your fleet and equipment, and offers a wealth of information to facilitate peak machine performance. By creating a tightly integrated web of support it allows proactive and preventive maintenance and helps to efficiently run a business.

Power

The detailed information that Komtrax puts at your fingertips 24 hours a day, 7 days a week gives the power to make better daily and long-term strategic decisions – at no extra cost. Problems can be anticipated, maintenance schedules customised, downtime minimised and machines kept where they belong: working on the jobsite.



Work equipment

Komatsu blades

For increased blade performance and better machine balance, Komatsu uses a box blade design, with the highest resistance for a light weight blade. Special highly wear resistant steel is used for the front and sides of the blade to increase durability. The deep curved design of the blade makes it easy to handle a wide range of materials, with good penetration and a large capacity, optimising high dozing performance with excellent fuel efficiency.



Komatsu rippers

Komatsu rippers were designed to combine the highest productivity with a long lifetime. The shank is fitted with special wear parts that increase longevity, and offer the best penetration in various types of materials.

Multishank parallelogram ripper (option)

The multishank parallelogram ripper has 3 ripper shanks as standard, but can be easily converted to a single or two-shank ripper, depending on job conditions. The strong parallelogram design offers straight shank movement, adapted for tough applications.

Straight Power Angle Tilt blade with adjustable pitch

The straight Power Angle Tilt blade (INPAT), offers a wide range of working modes. The large diameter centreball design offers a strong and durable solution for the blade attachment to the INPAT frame reducing maintenance costs.





Tough and reliable

EXi undercarriage

The EXi undercarriage has been specially designed for working on hard ground. The small to medium-width shoes and PLUS link assembly ensure a large contact area between the machine and the ground for maximum stability, grading performance and undercarriage lifetime.

PXi undercarriage

The PXi undercarriage is ideal for working on soft surfaces. The wide shoes and PLUS link assembly ensure a large contact area between the machine and the ground for maximum stability, grading performance and undercarriage lifetime.

Low-drive 'PLUS' undercarriage

Komatsu's low-drive Parallel Link Undercarriage System (PLUS) is extraordinarily tough, with excellent grading performance and stability. It features PLUS link assemblies, a highly reliable rotating bushing concept, substantial track link height, superior oil seals and track guards that maximise undercarriage durability. For easier servicing, the equaliser bar's centre pin is remotely greased. The segmented sprockets are notched to considerably improve the evacuation of mud and further increase the PLUS undercarriage lifetime.



Individual links can be replaced with common track tools

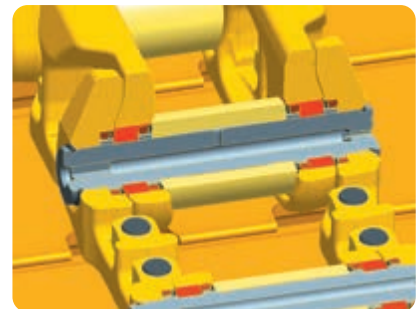

Rotating bushings





Sturdy, rugged design

A high-rigidity simple hull frame structure combined with thick plates and steel castings provide increased reliability and durability. All hydraulic piping is robustly protected by cover and inner route to ensure damage protection from materials.



Modular design

The D51EXi/PXi-24 was designed and manufactured to have low maintenance costs and a long lifetime. This was achieved mainly by reducing component complexity and with a strong modular design.



Self-adjusting idler support

The self-adjusting idler support provides constant and even tension on idler guide plates. It reduces noise levels and vibrations and increases undercarriage life.



Easy maintenance



Reversible swing-up fan

The D51EXi/PXi-24 includes a swing-up fan with a gas strut-assisted lift locking system to provide easy access to the radiator, oil cooler, and charge air cooler. The operator can switch the hydraulic fan to 'cleaning' mode so that it rotates in reverse at full speed to clean the radiators, reducing maintenance costs and improving fuel efficiency.



Simple and convenient service

Daily service and maintenance checks are made easy and safe. Sampling ports, remote grease points and service points are accessible from ground level. The engine fuel and oil filters are easily accessible in the front of the engine compartment, thanks to the location of the cooling fan at the rear of the machine.



Self-diagnostic monitor

The multifunction monitor panel displays the running time, engine revs, fuel level and water coolant temperature in real time. It also provides the operator with maintenance and service information, if oil filters need replacing or any abnormality occurs. In addition, it supplies Komatsu mechanics with detailed information, with no need for external service tools.

Komatsu Care

Komatsu Care is a maintenance program that comes as standard with your new Komatsu machine. It covers factory-scheduled maintenance, performed with Komatsu Genuine parts by Komatsu-trained technicians. It also offers extended coverage of the Komatsu Diesel Particulate Filter (KDPF) and of the Selective Catalytic Reduction (SCR). Please contact your local Komatsu distributor for terms and conditions.

Modular power train

All the power train components are enclosed in a sealed module. This eliminates oil spills during mounting and dismounting, and prevents dust and dirt polluting individual components. Servicing is much cleaner, smoother and easier.

AdBlue® tank

The AdBlue® tank is easily accessible on the left hand side of the machine.





Safety first

Optimal jobsite safety

Safety features on the Komatsu D51EXi/PXi-24 comply with the latest industry standards and work in synergy to minimise risks to people in and around the machine. A seat belt caution indicator and an audible travel alarm further increase safety.



Higher safety with iMC

Staking, surveying and final inspection were usually done manually. The D51EXi/PXi-24 reduces or eliminates the need for this ground staff around the machine. No more worries about blade mounted antennas or cables. The cab top GNSS antennas reduce risk of damage and theft.



LED lighting system

Long life, high lumen LED lights are standard on the machine. They are ideally positioned to give an optimal illumination of the work area.



Rear-view camera system

The rear-view monitor gives the operator a clear view of the rear area of the machine or the ripper. This allows to focus on the work at hand, even in low light conditions.

Specifications

Engine

Model	Komatsu SAA4D107E-5
Type	Common rail direct injection, water-cooled, emissionised, turbocharged, after-cooled diesel
Engine power	
at rated engine speed	2200 rpm
ISO 14396	99.0 kW / 133 HP
ISO 9249 (net engine power)	98.0 kW / 131 HP
No. of cylinders	4
Bore × stroke	107 mm × 124 mm
Displacement	4.5 l
Fan drive type	Hydraulic, reversible
Lubrication system	
Method	Gear pump, force lubrication
Filter	Full flow
Fuel	Diesel fuel, conforming to EN590 Class 2/Grade D. Paraffinic fuel capability (HVO, GTL, BTL), conforming to EN 15940:2016

Hydrostatic transmission

Dual-path, hydrostatic transmission provides infinite speed changes up to 9.0 km/h. The variable capacity travel motors allow the operator to select the optimum speed to match specific jobs. Travel control lock lever and neutral switch.

Max. travel speeds (EXi/PXi)

Quick shift mode*	Forward	Reverse
1st	0 - 3.4 km/h	0 - 4.1 km/h
2nd	0 - 5.6 km/h	0 - 6.5 km/h
3rd	0 - 9.0 km/h	0 - 9.0 km/h
Variable speed mode	Forward	Reverse
	0 - 9.0 km/h	0 - 9.0 km/h

* Quick shift speeds are adjustable on the monitor

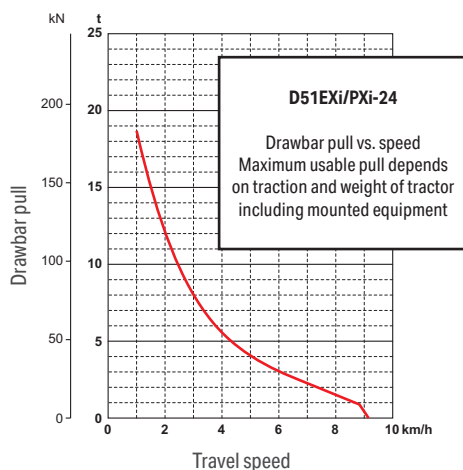

Final drive

Type	Spur and planetary gear, double-reduction
Sprocket	Segmented sprocket teeth are bolt-on for easy replacement

Steering system

Type	Hydrostatic Steering System (HSS)
Steering control	PCCS-lever
Minimum turning radius (counter-rotation) as measured by track marks on ground	
D51EXi-24	2.5 m
D51PXi-24	2.7 m

Undercarriage

Suspension	Oscillating equaliser bar and pivot shaft
Track roller frame	Monocoque, large section, durable construction
Tracks	PLUS link assembly
Track tension	Combined spring and hydraulic unit
Number of shoes (each side)	44
Grouser height (single grouser)	55 mm
Track rollers (each side)	7
Carrier rollers (each side)	2
Shoe width (standard)	
D51EXi-24	560 mm
D51PXi-24	710 mm
Ground contact area (ISO 16754)	
D51EXi-24	30630 cm ²
D51PXi-24	38840 cm ²
Ground pressure (ISO 16754)	
D51EXi-24	0.45 kgf/cm ²
D51PXi-24	0.37 kgf/cm ²

Environment

Engine emissions	Fully complies with EU Stage V exhaust emission regulations
Noise levels	
LwA external	106 dB(A) (2000/14/EC Stage II)
LpA operator ear	76 dB(A) (ISO 6396 dynamic test)
Vibration levels (EN 12096:1997)	
Hand/arm	≤ 2.5 m/s ² (uncertainty K = 1.07 m/s ²)
Body	≤ 0.5 m/s ² (uncertainty K = 0.28 m/s ²)
Contains fluorinated greenhouse gas HFC-134a (GWP 1430). Quantity of gas 1.1 kg; CO ₂ equivalent 1.57 t	

Operating weight (appr.)

Including INPAT blade, hitch, ROPS/FOPS cab, operator, rated capacity of lubricant, coolant, and full fuel tank.	
D51EXi-24	13820 kg
D51PXi-24	14300 kg

Hydraulic system

Type	CLSS (closed-centre load sensing system)
All spool valves externally mounted beside the hydraulic tank	
Maximum pump flow	107 l/min
Relief valve setting	280 kgf/cm ²
Spool control valve positions	
Blade lift	Raise, hold, lower, and float
Blade tilt & angle	Right, hold, and left
Additional control valve positions for ripper	
Ripper lift	Raise, hold, and lower
Hydraulic cylinders	
No. of cylinders × bore	
Blade lift	2 × 90 mm
Blade tilt	1 × 100 mm
Blade angle	2 × 90 mm

Machine dimensions

	D51EXi-24	D51PXi-24
A	3045 mm	3350 mm
B	425 mm	470 mm
C	1120 mm	1170 mm
D	1015 mm	1035 mm
E	455 mm	475 mm
F	2735 mm	2735 mm
G	4800 mm	4850 mm
H	3175 mm	3175 mm
I	55 mm	55 mm
J	1790 mm	1880 mm
K	560 mm	710 mm
L	2350 mm	2590 mm
M	2720 mm	2990 mm
N	5485 mm	5605 mm

Service refill capacities

Fuel tank	270 l
Radiator	25 l
Engine oil	15.5 l
Hydraulic tank	63 l
Final drive (each side)	5.5 l
AdBlue® tank	40 l

Multishank ripper

Type	Hydraulically controlled parallelogram ripper
No. of shanks	3
Weight (including hydraulic control unit)	860 kg
Beam length	1556 mm
Maximum lift above ground	380 mm
Maximum digging depth	425 mm

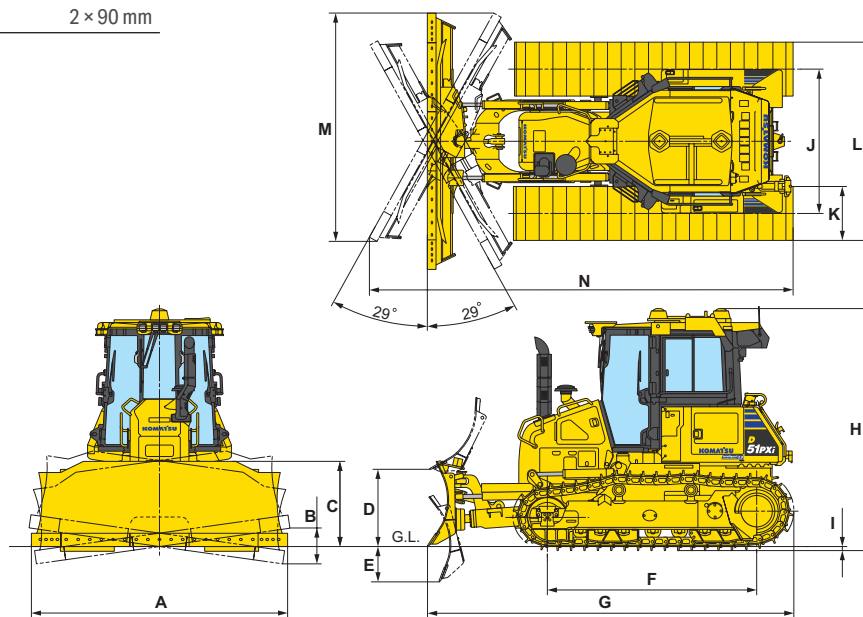

Ground clearance: 390 mm (+ grouser height)

Dozer equipment

	Overall length with dozer	Blade width × height	Maximum lift above ground	Maximum drop below ground	Maximum tilt adjustment	Blade angle
2.7 m ³ INPAT blade (EXi) (option)	4800 mm	3045 × 1120 mm	1015 mm	455 mm	425 mm	28°
2.9 m ³ INPAT blade (EXi) (standard)	4800 mm	3350 × 1130 mm	1015 mm	455 mm	470 mm	28°
2.9 m ³ INPAT blade (PXi) (option)	4800 mm	3350 × 1120 mm	1015 mm	455 mm	470 mm	28°
3.35 m ³ INPAT blade (PXi) (standard)	4850 mm	3350 × 1170 mm	1035 mm	475 mm	470 mm	28°

Blade capacities are based on the SAE recommended practice J1265.

Standard and optional equipment

Engine

Komatsu SAA4D107E-5 turbocharged common rail direct injection diesel engine	●
EU Stage V compliant	●
Auto-deceleration function	●
Adjustable idle shutdown	●
Fuel pre-filter (10 micron) and fuel filter (2 micron)	●
Exhaust pipe with elbow	●
Intake pipe with rain cap	●
Fuel tank inlet strainer	●
Alternator 24 V / 85 A	●
Starter motor 24 V / 4.5 kW	●
Batteries 2 × 12 V / 92 Ah	●
Intake pipe with air pre-cleaner	○

Intelligent Machine Control 2.0

Standard factory installed integrated 3D GNSS intelligent Machine Control system	●
Smart Construction Remote	○

Transmission and brakes

Electronically controlled HST	●
Palm lever steering control (PCCS)	●
Quick shift selection system	●
Variable speed mode	●
Reverse speed presets	●
Combined decelerator/brake pedal	●

Undercarriage

Komatsu PLUS link assembly	●
Single grouser heavy-duty shoes (EXi: 560 mm; PXi: 760 mm)	●
Segmented sprockets	●
Idler cushions	●
Track roller guard, centre and end section	●
Full length track roller guard	○

Hydraulic system

Hydraulics for dozing blades	●
Mono lever blade control	●
Hydraulics for ripper	○

Cabin

Air-suspended seat: fabric, reclining, heated, high backrest	●
Seat belt with visible alert	●
High mount footrest	●
Air conditioner	●
Radio with Bluetooth® and USB	●
Auxiliary input (MP3 jack)	●
2 × 12 Volt power supply (120 W)	●
1 × 24 Volt power supply	●
Viscous cab mounts	●
Rear-view mirror (inside cab)	●
Front window sun roller blind	●
Wiper front window	●
Wiper rear window	●
Wipers doors	●
Cup holder	●

Service and maintenance

Swing-out hydrostatic-driven radiator fan with reversing function	●
Dry type air cleaner, double element with dust indicator and evacuator	●
Water separator	●
Multi-function video compatible colour monitor with Equipment Management and Monitoring System (EMMS) and efficiency guidance	●
Komtrax – Komatsu wireless monitoring system (4G)	●
Komatsu Care – a maintenance program for Komatsu customers	●
Tool kit	●
Grease gun holder	●
Shovel holder	●
Sampling ports for oils and coolant	●

LED lighting system

LED working lights, 4 cab roof front, 2 cab roof rear	●
---	---

Safety equipment

Steel cab, meets ISO 3471 and SAE J1040, APR88 ROPS standards, as well as ISO 3449 FOPS standards	●
Horn	●
Locks, filter caps and covers	●
Back-up alarm	●
Rear-view camera system	●
Fire extinguisher	●
Battery main switch (lockable)	●
Secondary engine shutdown switch	●
Seat belt caution indicator	●
Tie-off points	●
Handrails	●

Dozer equipment

2.9 m ³ INPAT blade (EXi)	●
3.35 m ³ INPAT blade (PXi)	●
2.7 m ³ INPAT blade (EXi)	○
2.9 m ³ INPAT blade (PXi)	○

Other equipment

Front pull hook	●
Hitch (not with ripper)	●
Multishank parallelogram ripper	○
Rigid drawbar	○

Further equipment on request

- standard equipment
- optional equipment



A wide range of blades and attachments is available. Your Komatsu distributor is ready to assist you with the selection of suitable options.

This specification sheet may contain attachments and optional equipment that are not available in your area. Please consult your local Komatsu distributor for those items you may require.

Materials and specifications are subject to change without notice.

Your Komatsu partner:

KOMATSU

[komatsu.eu](https://www.komatsu.eu)

